

**duravent™**

# PelletVent Pro®

Biofuel Venting System

UL 641, ULC S609, and ULC/ORD C441



**AV**

## Specifications

### Applications

PelletVent Pro is a venting system designed for stoves and inserts that use wood pellets and oil fuel. It is also built to vent biofuel products such as corn, switch grass, cherry pits, soybeans, coffee husks, sunflower hulls, walnut shells and wheat, to name a few. (Rated for continuous use flue temperatures up to 570° F.)

### Materials and Construction

Laser-welded, double-wall pipe with a .012" inner wall of corrosion resistant stainless steel and a .018" laser-welded galvalume outer wall. Painted black exterior available. Primary metal-to-metal connection seals joint. Encapsulated o-ring provides a secondary seal.

### Clearances

1" clearance to combustibles in the USA and Canada for appliances using corn and other biofuels, wood pellets or oil.

### Diameters

3" & 4"

### Listings

c-UL-us Listed to UL 641, ULC S609, and ULC/ORD C441 (MH8381 and MH14420).



## UL 641, ULC S609, and ULC/ORD C441 System

### PelletVent Pro for biofuels

All PelletVent Pro® components that come into contact with flue gases are built with an inner wall of corrosion resistant metal. PelletVent Pro is engineered with features for a durable, safe and aesthetically pleasing venting system. PelletVent Pro is a venting system for stoves and inserts that use wood pellets, corn and other biofuels, or oil, as fuel. As a result of Duravent's cutting-edge manufacturing process and commitment to innovation, PelletVent Pro is uncompromised in attention to detail and performance. This perfect fit and finish is made possible with a laser-welded inner and outer wall. Select components are available in black.

PelletVent Pro is UL listed for 1" clearance to combustibles in the USA and in Canada. It's double-wall, air-insulated design offers superior performance. Seams are factory-sealed on all elbows, tees, and fittings.

Since the introduction of pellet stoves in the 1980's, Duravent is recognized as the industry leader in venting systems for pellet stoves. For over 20 years, Duravent's PelletVent has been the number 1 choice for installers. The reasons are clear—it works, it looks great, and it lasts!



## Typical Installations

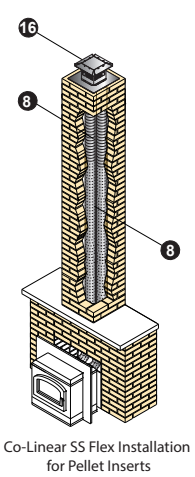

Co-Linear SS Flex Installation for Pellet Inserts

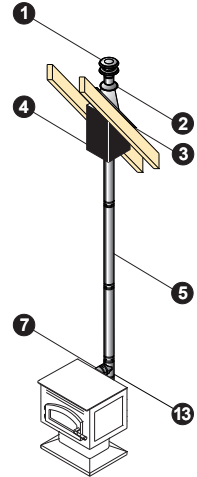

Cathedral Ceiling Stove Installation

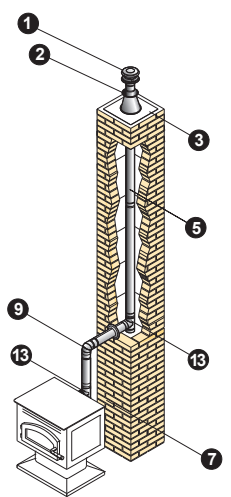

Masonry Chimney Relining with Rigid Pipe

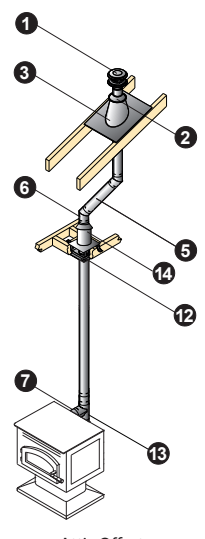

Attic Offset

Installation Key			
1	Vertical Cap	10	Horizontal Cap with Rigid Pipe
2	Storm Collar	11	Wall Thimble
3	Flashing	12	Ceiling Support Firestop Spacer
4	Cathedral Ceiling Support Box	13	Tee w/ Clean-Out Tee Cap
5	Straight Length Pipe	14	Wall Strap
6	45° Elbow	15	Attic Insulation Shield
7	Appliance Adapter	16	Prairie Termination Cap
8	Flex Length	17	CAS Adjustable Wall Channel
9	90° Elbow		

- Refer to our Typical Venting Installation drawings to select the appropriate component parts for your installation.
- The inner pipe diameter should match the outlet size of the appliance. For installations that require 4" vent where the appliance has a 3" outlet, use an Increaser Adapter 3"-4".
- Check the appliance manufacturer's installation instructions to confirm which types of vent configurations are permitted (i.e., horizontal, vertical, chimney reline, etc.). Also, check for any venting restrictions such as maximum horizontal run, minimum and maximum vertical rise, maximum offset, etc.
- Be fire safe! Maintain the minimum clearances (air-space) between the vent pipe and nearby combustibles, as specified in the appliance manufacturer's installation instructions. Use proper support and bracing. Follow local building codes and have your venting system inspected.

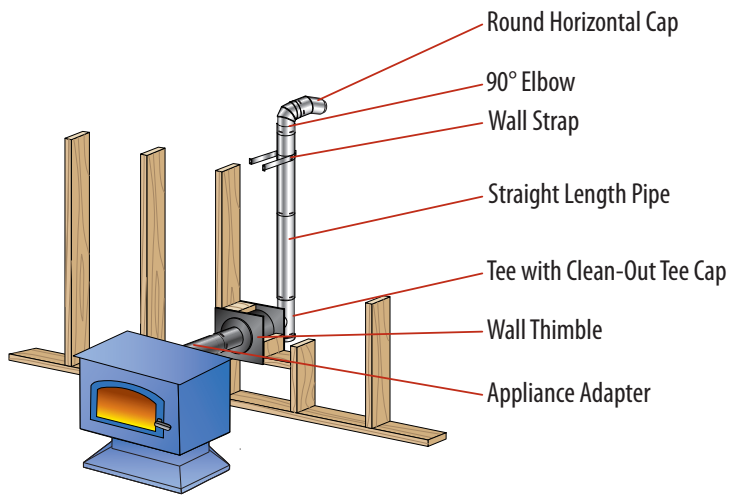

## Planning Your Installation

1	Refer to the Typical PelletVent Pro Installations diagram, on the opposite page, to be familiar with some of the standard PelletVent Pro installations and the required component parts.
2	For a horizontal termination, you will need a Wall Thimble and a Horizontal Cap. The cap must be installed with a 6" clearance to the outside wall (refer to appliance manufacturer's installation instructions for other clearances).
3	For a vertical termination, you will need a Cathedral Ceiling Support Box or Flat Ceiling Support, Attic Insulation Shield (if passing through an attic), Flashing, Storm Collar, and Vertical Cap.
4	Determine the length of PelletVent Pro pipe required. For a vertical termination, measure the pitch of the roof and select the proper flashing. The required minimum height above the roof is 12".
5	Pellet stove inserts in masonry fireplaces will require a flex pipe to snake the vent past the smoke shelf. For transition from PelletVent Pro to an existing DuraPlus, DuraPlus HTC, or DuraTech Chimney, a Chimney Adapter is available.
6	For vertical rise of PelletVent Pro on the outside of the house, Wall Straps should be used at 4' intervals to provide proper support.
7	Important! Check to be sure that the appliance and the venting system are in compliance with all minimum clearance to combustibles requirements.

## Design Recommendations

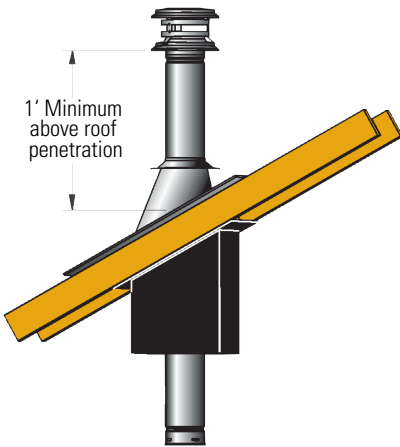

The following design recommendations are a general guideline to assist in the design and selection of venting components for your installation. Always follow Duravent Installation instructions before installing your chimney system (found with the cap or support box). Installation instructions can be viewed online at [www.duravent.com](http://www.duravent.com), under Catalogs and Instructions.

- Size the vent to meet the appliance manufacturer's specifications.
- Avoid long runs and excessive use of elbows. Refer to the appliance manufacturer for minimum rise and maximum run configurations for the venting system.
- Use an Appliance Adapter to ensure a proper connection to appliance. Seal adapter to appliance with high temperature sealant.
- Use a Single Tee with Clean-Out Tee Cap to facilitate easy cleaning. It is recommended to use a tee off the back of an appliance.
- In the United States and Canada, maintain the minimum 1" clearance (air space) from vent pipe to combustibles. Use proper support and bracing. Follow local building codes and have your venting system inspected. Be fire safe!

### PelletVent Pro Horizontal Kit



Kit includes: Horizontal Cap, Wall Thimble, and Appliance Adapter. Pipe lengths not included. 4" Kit includes a 3"-4" Appliance Adapter/Increaser, painted black.

SIZE	ORDER #	STOCK #
3"	3PVP-KHA	810001029
4"	4PVP-KHA	810001035

### PelletVent Pro Vertical Kit - Flat Ceiling



Kit includes: Vertical Cap, Storm Collar, Ceiling Support Firestop Spacer, Adjustable Flashing, and Appliance Adapter. Pipe lengths not included. 4" Kit includes a 3"-4" Appliance Adapter/Increaser, painted black. Support Clamp included.

SIZE	ORDER #	STOCK #
3"	3PVP-KVA	810001031
4"	4PVP-KVA	810001036

### PelletVent Pro Vertical Kit - Cathedral



Kit includes: Vertical Cap, Storm Collar, Cathedral Ceiling Support Box with trim and clamp, Adjustable Flashing, and Appliance Adapter. Pipe lengths not included. 4" Kit includes a 3"-4" Appliance Adapter/Increaser, painted black.

SIZE	ORDER #	STOCK #
3"	3PVP-KVB	810001033
4"	4PVP-KVB	810001037

### Straight Length Pipe

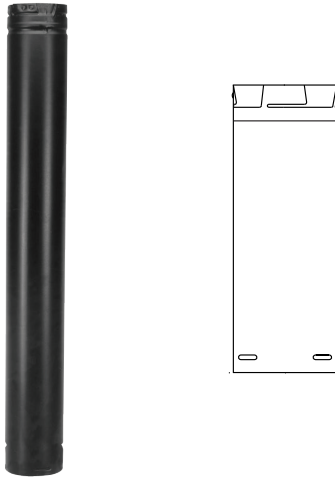

Features fully unitized, twist-lock construction in 3" and 4" diameters. Listed at 1" clearance to combustibles in the USA and Canada. It can be used in both vertical and horizontal installations. Stainless steel welded seam inner wall, combined with a galvalume welded seam outer wall. Pipe OD is diameter plus 5/8". Galvalume or painted black outer finish. 12" length available with stainless steel outer (SS). To calculate installed length, subtract 1 1/2" from each length of pipe.

SIZE	3"		4"	
	ORDER #	STOCK #	ORDER #	STOCK #
6"	3PVP-06	810001038	4PVP-06	810001104
6" BLACK	3PVP-06B	810001039	4PVP-06B	810001105
12"	3PVP-12	810001040	4PVP-12	810001106
12" BLACK	3PVP-12B	810001041	4PVP-12B	810001107
12" STAINLESS STEEL	3PVP-12SS	810001042	---	---
18"	3PVP-18	810013711	4PVP-18	810013712
24"	3PVP-24	810001043	4PVP-24	810001109
24" BLACK	3PVP-24B	810001044	4PVP-24B	810001110
36"	3PVP-36	810001046	4PVP-36	810001112
36" BLACK	3PVP-36B	810001047	4PVP-36B	810001113
48"	3PVP-48	810013989	4PVP-48	810013990
48" Black	3PVP-48B	810013991	4PVP-48B	810013992
60"	3PVP-60	810001048	4PVP-60	810001114
60" BLACK	3PVP-60B	810001049	4PVP-60B	810001115

### Pipe Extension

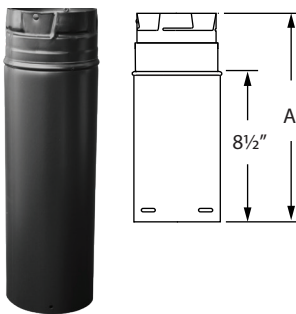

Use to add length to PelletVent Pro pipe. 12" pipe adds 3"-10" of length, 18" pipe adds 3"-16" of length, when used with rigid sections of pipe. Galvalume or painted black outer finish.

SIZE	ORDER #	STOCK #	A
3"	3PVP-12A	810001050	3" - 10"
3" BLACK	3PVP-12AB	810001051	3" - 10"
3"	3PVP-18A	810001052	3" - 16"
3" BLACK	3PVP-18AB	810001053	3" - 16"
3"	3PVP-48A	810001054	4" - 46"
3" BLACK	3PVP-48AB	810001055	4" - 46"
4"	4PVP-12A	810001116	3" - 10"
4" BLACK	4PVP-12AB	810001117	3" - 10"
4"	4PVP-18A	810001118	3" - 16"
4" BLACK	4PVP-18AB	810001119	3" - 16"
4"	4PVP-48A	810001120	4" - 46"
4" BLACK	4PVP-48AB	810001121	4" - 46"

### Increaser

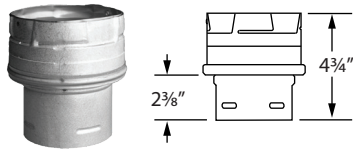

Use to transition from 3" pipe to a 4" pipe. It is not a reducer nor a stove adapter.

SIZE	ORDER #	STOCK #
3" - 4"	3PVP-X4	810001100

### Flex Pipe



Use for offsetting rigid pipe around smoke shelf in masonry chimney only. Allows for offsets with biofuel appliances. Female and male ends twist-lock. Female end swivels for easy alignment. 5' flex section. Not for use in attic or wall spaces.

SIZE	ORDER #	STOCK #
3"	3PVP-60F	810001056
4"	4PVP-60F	810001122

### Flex Trim Collar

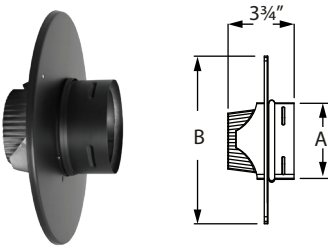

Use to connect PelletVent Pro rigid pipe to a masonry chimney with stainless steel flexible relining. Female end swivels to allow ease of connection.

SIZE	ORDER #	STOCK #	A	B
3"	3PVP-FTC	810001092	3 3/8"	8 1/2"
4"	4PVP-FTC	810001156	4 5/8"	8 1/2"

### Female Flex Adapter

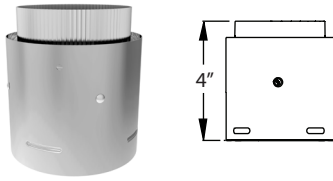

Use to connect PelletVent Pro to the bottom of BioFlex when relining a masonry chimney.

SIZE	ORDER #	STOCK #
3"	3PVP-ADFF	810001062
4"	4PVP-ADFF	810001125

### Male Flex Adapter

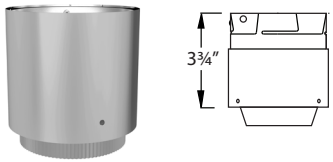

Use to connect the top of the BioFlex to PelletVent Pro when relining a masonry chimney.

SIZE	ORDER #	STOCK #
3"	3PVP-ADFM	810001063
4"	4PVP-ADFM	810001126

### Appliance Adapter

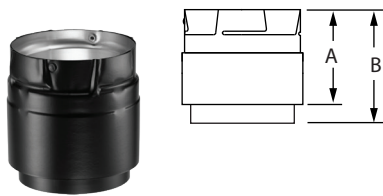

Use to attach to appliance outlet allowing for easy pipe connection. Seal adapter to appliance with high temperature sealant.

SIZE	ORDER #	STOCK #	SIZE	ORDER #	STOCK #
3"	3PVP-AD	810001057	4"	4PVP-AD	810001123
3" BLACK	3PVP-ADB	810001058	4" BLACK	4PVP-ADB	810001124

### Quick Release Adapter

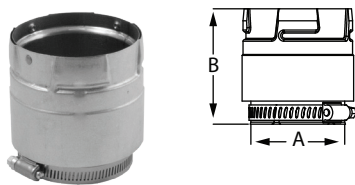

Use to attach to appliance outlet allowing for easy pipe connection. Features an adjustable hose clamp and gasket to form a tight seal. The hose clamp can be loosened and tightened as needed to disconnect and connect the vent to the appliance.

SIZE	ORDER #	STOCK #	A	B
3"	3PVP-ADS	810006994	3"	3 1/2"
4"	4PVP-ADS	810006995	4"	3 1/2"



### Ravelli, 80mm Adapter

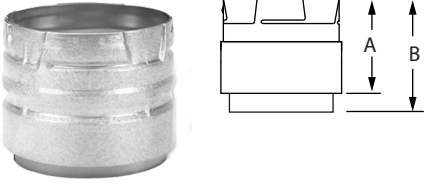

Use to provide a secure, tight fit to the exhaust outlet on any Ravelli Pellet Stove. Seal with high temperature silicone sealant to ensure a tight connection.

SIZE	ORDER #	STOCK #	A	B
3"	3PVP-ADR	810013232	3 1/4"	4 1/4"

### Harman Adapter



Use to provide a secure, tight fit to the exhaust outlet on any Harman Pellet Stove. Seal with high temperature silicone sealant to ensure a tight connection.

SIZE	ORDER #	STOCK #
3"	3PVP-ADHB	810001059

### Harman Adapter Increaser



Use to increase vent diameters. Specifically designed for Harman Pellet Stoves.

SIZE	ORDER #	STOCK #
3"	3PVP-X4ADHB	810005891

### Appliance Adapter/Increaser

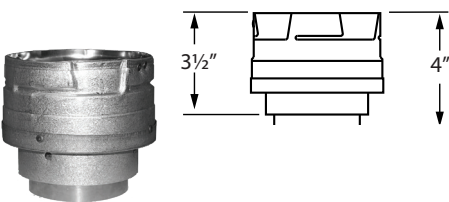

Use to attach to appliance outlet allowing for easy pipe connection. Allows connection of 4" vent to 3" appliance outlet. Seal adapter to appliance with high temperature sealant.

SIZE	ORDER #	STOCK #
3"	3PVP-X4AD	810001060
3" BLACK	3PVP-X4ADB	810001061

### 45° Elbow

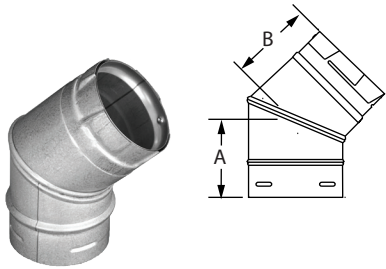

Offsets obstructions as needed. Elbows swivel 360° at base. Angle is not adjustable.

SIZE	ORDER #	STOCK #	A	B
3"	3PVP-E45	810001064	3 7/8"	4"
3" BLACK	3PVP-E45B	810001065	3 7/8"	4"
4"	4PVP-E45	810001127	3 7/8"	4"
4" BLACK	4PVP-E45B	810001128	3 7/8"	4"

### 90° Elbow

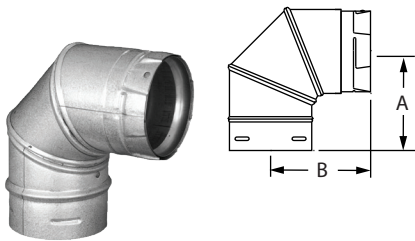

Offsets obstructions as needed. Elbows swivel 360° at base. Angle is not adjustable.

SIZE	ORDER #	STOCK #	A	B
3"	3PVP-E90	810001066	5 1/2"	5 1/2"
3" BLACK	3PVP-E90B	810001067	5 1/2"	5 1/2"
4"	4PVP-E90	810001129	5 1/2"	5 1/2"
4" BLACK	4PVP-E90B	810001130	5 1/2"	5 1/2"

# PelletVent Pro<sup>®</sup> Tees

Duravent now offers a newly redesigned PelletVent Pro<sup>®</sup> Clean Out Tee.

This new tee features a spring button design that enables an easier twist removal of the clean out cap and a new, lower profile that makes it easier to clean and maintain your pellet stove.



### Single Tee w/ Clean-Out Tee Cap

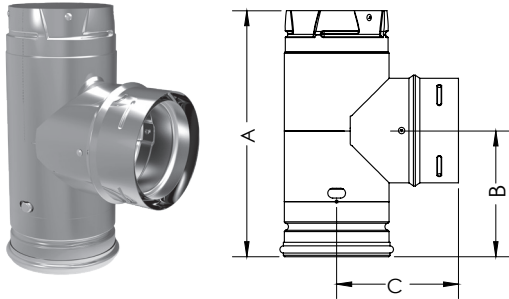

Use for a 90° offset. Branch swivels for alignment. One piece unit incorporates removable twist-lock Clean-Out Tee Cap.

SIZE	ORDER #	STOCK #	A	B	C
3"	3PVP-T1	810013513	8 1/2"	4 3/8"	4 1/4"
3" BLACK	3PVP-TB1	810013810	8 1/2"	4 3/8"	4 1/4"
4"	4PVP-T1	810013820	9 5/8"	4 7/8"	4 3/4"
4" BLACK	4PVP-TB1	810013821	9 5/8"	4 7/8"	4 3/4"

### Increaser Tee w/ Clean-Out Tee Cap

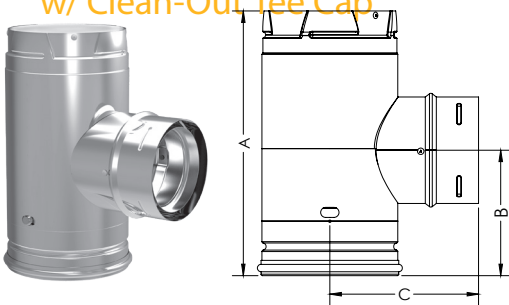

Attaches 3" pipe to branch and 4" pipe to body. Use for a 90° offset. Branch swivels for alignment. One piece unit incorporates removable twist-lock Clean-Out Tee Cap.

SIZE	ORDER #	STOCK #	A	B	C
4"	4PVP-T31	810013822	9"	4 1/4"	5 3/5"
4" BLACK	4PVP-T3B1	810013823	9"	4 1/4"	5 3/5"

### Adapter Tee w/ Clean-Out Tee Cap

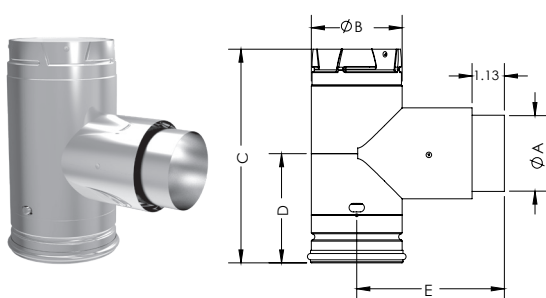

Use for a 90° offset. Attaches directly to appliance as an adapter. One piece unit incorporates removable twist-lock Clean-Out Tee Cap.

SIZE	ORDER #	STOCK #	A	B	C	D	E
3"	3PVP-TAD1	810013811	3"	3 5/8"	8 1/2"	4 3/8"	5 3/4"
3" BLACK	3PVP-TADB1	810013812	3"	3 5/8"	8 1/2"	4 3/8"	5 3/4"
4"	4PVP-TAD1	810013824	4"	4 5/8"	9 5/8"	4 7/8"	6 3/8"
4" BLACK	4PVP-TADB1	810013825	4"	4 5/8"	9 5/8"	4 7/8"	6 3/8"

### Increaser Adapter Tee w/ Clean-Out Tee Cap

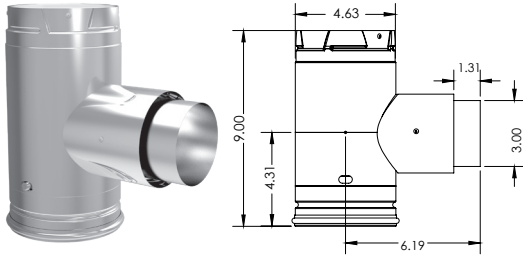

Use for a 90° offset. Attaches directly to appliance as an adapter. Converts a 3" appliance to a 4" PelletVent Pro system. One piece unit incorporates removable twist-lock Clean-Out Tee Cap.

SIZE	ORDER #	STOCK #
3"	3PVP-TADX41	810013813
3" BLACK	3PVP-TADX4B1	810013814

### Double Tee w/ Clean-Out Tee Cap

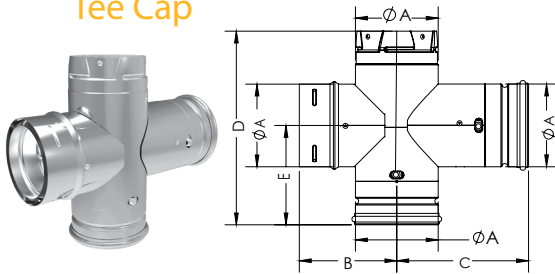

Allows clean-out access for horizontal and vertical installations. Use for a 90° offset. Branch swivels for alignment. One piece unit incorporates removable twist-lock Clean-Out Tee Cap.

SIZE	ORDER #	STOCK #	A	B	C	D	E
3"	3PVP-DBT1	810013815	3 5/8"	4 1/4"	5 3/4"	8 1/2"	4 3/8"
3" BLACK	3PVP-DBTB1	810013816	3 5/8"	4 1/4"	5 3/4"	8 1/2"	4 3/8"
4"	4PVP-DBT1	810013826	4 5/8"	5"	6 3/8"	9 5/8"	4 6/8"
4" BLACK	4PVP-DBTB1	810013827	4 5/8"	5"	6 3/8"	9 5/8"	4 6/8"

### Clean-Out Tee Cap

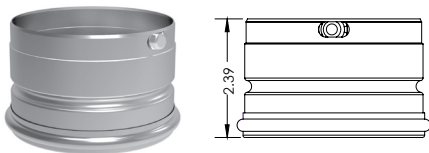

Use as a replacement Clean-Out Tee Cap. The new PelletVent Pro Tee Cap is a tight fit by design. We recommend using rubber gloves or a strap wrench to easily remove.

SIZE	ORDER #	STOCK #
3"	3PVP-CO1	810013817
3" BLACK	3PVP-COB1	810013818
4"	4PVP-CO1	810013828
4" BLACK	4PVP-COB1	810013829

### Replacement Gaskets -

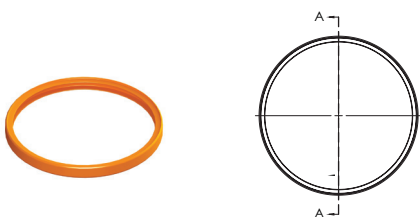

Use as a replacement gasket for PelletVent Pro Clean-out Tee Caps. Available in packs of 12 for 3" and 4" sizes.

SIZE	ORDER #	STOCK #
3"	3PVP-GA1	810014147
4"	4PVP-GA1	810014148

### Wall Thimble

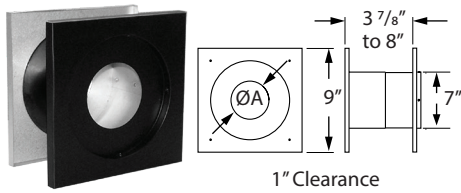

Use for through-the-wall installations. Fits between standard wall studs. Comes with an insulation ring to reduce air infiltration where the pipe slips through the thimble.

SIZE	ORDER #	STOCK #	A
3"	3PVP-WT	810001081	3 3/4"
4"	4PVP-WT	810001145	4 3/4"

### 2" diameter Fresh Air Intake Kit

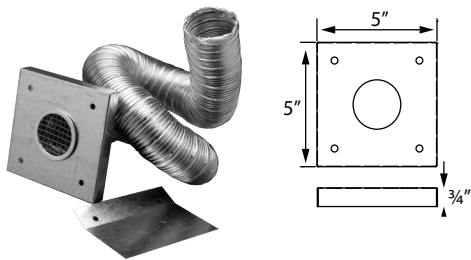

Kit includes: faceplate with screen, deflector, length of 2" aluminum flex, and two clamps. Allows fresh air into an existing pellet stove installation that had been using inside air. Allows an installer to decide the best possible location for the air intake vent, not the same location as the wall thimble. The flex length comes compressed and can be stretched to approximately 10 feet.

SIZE	ORDER #	STOCK #
3"	3PVP-AIK	810001034

### 3" diameter Fresh Air Intake Kit

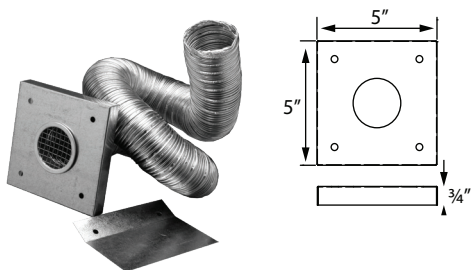

Kit includes: faceplate with screen, deflector, length of 3" aluminum flex, and two clamps. Allows fresh air into an existing pellet stove installation that had been using inside air. Allows an installer to decide the best possible location for the air intake vent, not the same location as the wall thimble. The flex length comes compressed and can be stretched to approximately 10 feet.

SIZE	ORDER #	STOCK #
4"	4PVP-AIK	810013123

### Fresh Air Inlet Increaser

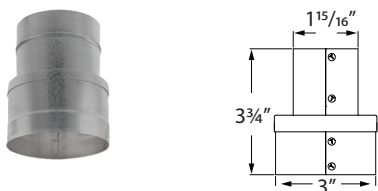

Use to increase an insert's 2" air inlet to connect to 3" aluminum flex.

SIZE	ORDER #	STOCK #
3"	3PVP-INC	810001103

### Wall Thimble Air Intake Kit

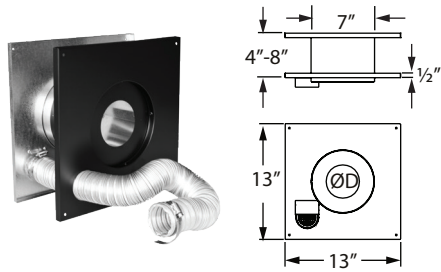

Allows outside fresh air for combustion through the wall thimble without having to cut a second hole into the wall. Comes with an insulation ring to reduce air infiltration where the pipe slips through the thimble. The 2" diameter flex hose is 10' in length. Clamps included. Can be used in US and Canada. Patented.

SIZE	FLEX Ø	ORDER #	STOCK #
3"	2"	3PVP-WTI	810001083
4"	2"	4PVP-WTI	810001147
4"	3"	4PVP-WTI3	810001148

### Ceiling Support Firestop Spacer

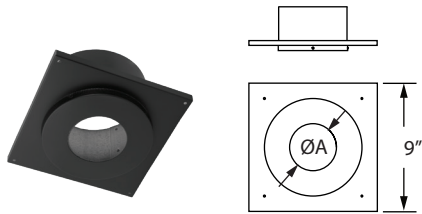

Required where vent passes through ceiling. Centers pipe to provide proper 1" clearance. Support Clamp included. Painted black.

SIZE	ORDER #	STOCK #	A
3"	3PVP-FS	810001084	3 3/4"
4"	4PVP-FS	810001149	4 3/4"

### Wall Strap

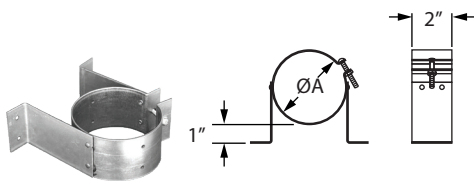

Use to support vent pipe or tee sections. Provides 1" clearance.

SIZE	ORDER #	STOCK #	A
3"	3PVP-WS	810001086	3 5/8"
4"	4PVP-WS	810001151	4 5/8"

### Adjustable Wall Strap

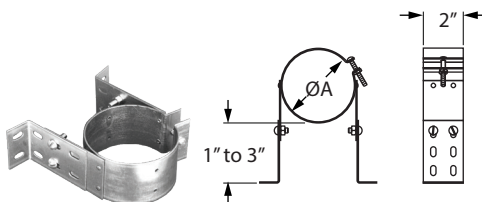

Use to support vent pipe or tee sections. Adjusts to provide 1"- 3" clearance.

SIZE	ORDER #	STOCK #	A
3"	3PVP-WSA	810001087	3 5/8"
4"	4PVP-WSA	810001152	4 5/8"

### Wall Strap Extension

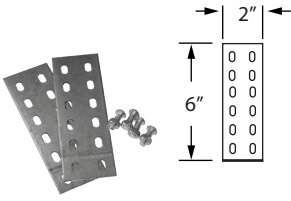

Use with Adjustable Wall Strap to increase extension from wall. Fits both 3" and 4" Adjustable Wall Strap.

SIZE	ORDER #	STOCK #
3"-4"	3PVP-WSA-EXT	810001088

### Cathedral Ceiling Support Box

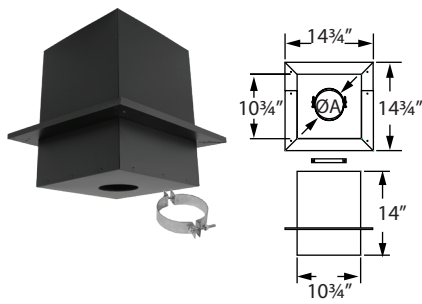

Use to support pipe. May be used on flat ceilings. Painted black. Trim and clamp included.

SIZE	ORDER #	STOCK #	A
3"	3PVP-CS	810001089	3 3/4"
4"	4PVP-CS	810001153	4 3/4"

### C Clamp



Clamp for applications where existing factory-built chimney is being relined for pellet.

SIZE	ORDER #	STOCK #
3"	3PVP-CC	810013282
4"	4PVP-CC	810013283

### House Shield

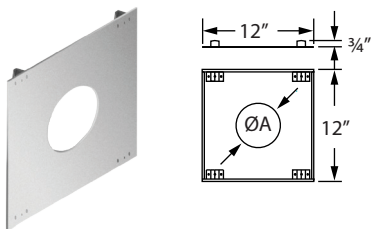

Use to protect exterior of structure from blower discharge in horizontal venting applications.

SIZE	ORDER #	STOCK #	A
3"	3PVP-HS	810001090	3 3/4"
4"	4PVP-HS	810001154	4 3/4"



### Attic Insulation Shield

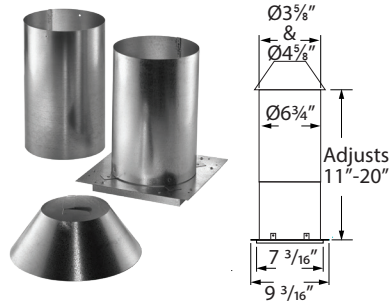

Required for installations that pass through an attic to prevent insulation and debris from accumulating near the vent. Provides 1" clearance to combustibles.

SIZE	ORDER #	STOCK #
3"	3PVP-IS	810001093
4"	4PVP-IS	810001157

### Adjustable Roof Flashing

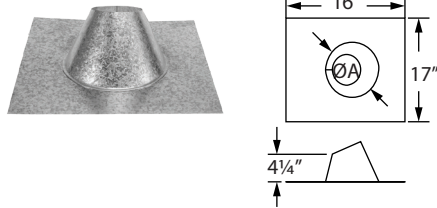

Use to weatherproof the penetration of vent pipe through the roof. Storm Collar required. Select roof flashing based on pitch of roof. For pitches of 0/12 - 6/12.

SIZE	ORDER #	STOCK #	A
3"	3PVP-F6	810001094	3 3/4"
4"	4PVP-F6	810001158	4 3/4"

### Steep Roof Flashing

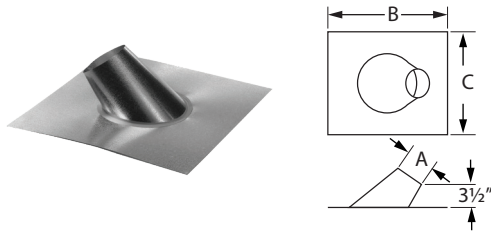

Use to weatherproof the penetration of vent pipe through the roof. Storm Collar required. Select roof flashing based on pitch of roof. For pitches 7/12 - 12/12. Made of galvalume.

SIZE	ORDER #	STOCK #	A	B	C
4"	4PVP-F12	810012627	4 3/4"	15"	20"

### Tall Cone Roof Flashing

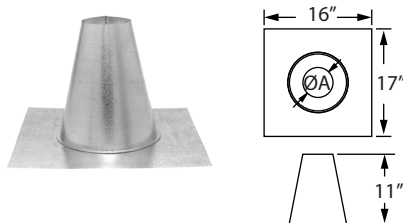

Use to weatherproof the penetration of vent pipe through the roof. Storm Collar required. Select roof flashing based on pitch of roof. Use on flat roofs, chase enclosures, or masonry chimney. Made of galvalume.

SIZE	ORDER #	STOCK #	A
3"	3PVP-FF	810001095	3 3/4"
4"	4PVP-FF	810001159	4 3/4"

### DSA Roof Flashings

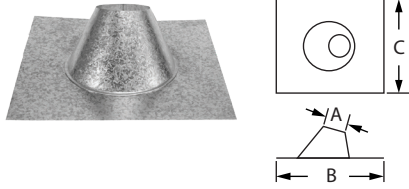

Use with metal or tile roofs. Available in sizes 3" and 4", in 0/12-6/12 (shown) and 7/12-12/12 styles. Made of dead soft aluminum.

SIZE	ORDER #	STOCK #	A	B	C	
3"	0/12-6/12	3PVP-F6DS	810001096	3 3/4"	19 3/8"	23"
	7/12-12/12	3PVP-F12DS	810001097	3 3/4"	19 3/8"	23"
4"	0/12-6/12	4PVP-F6DS	810001160	4 3/4"	19 3/8"	23"
	7/12-12/12	4PVP-F12DS	810001161	4 3/4"	19 3/8"	23"

### Storm Collar

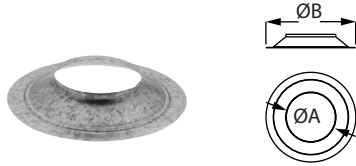

Use to maintain a weather tight resistant seal between the pipe and the flashing.

SIZE	ORDER #	STOCK #	A	B
3"	3PVP-SC	810001091	3 5/8"	7 3/8"
4"	4PVP-SC	810001155	4 5/8"	8 1/8"

### Vertical Cap

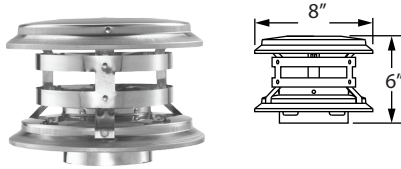

Use for vertical installations only. Required where pipe terminates above the roof line.

SIZE	ORDER #	STOCK #
3"	3PVP-VC	810001078
4"	4PVP-VC	810001141

### Horizontal Cap

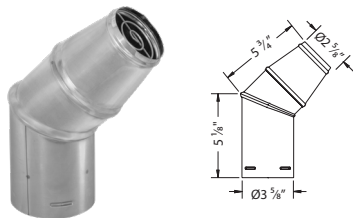

Use for horizontal terminations only. The Horizontal Cap can be turned at the gore to direct exhaust output. Designed to create a venturi effect to force exhaust out. Made of a laser-welded, corrosion resistant stainless steel inner wall that is scientifically proven to resist corrosion from corn and other biofuels. Outer wall made of laser-welded stainless steel.

SIZE	ORDER #	STOCK #
3"	3PVP-HC2	810009646
4"	4PVP-HC2	810009647

### Square Horizontal Cap

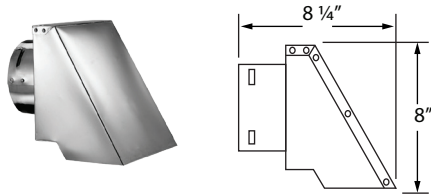

Use for horizontal terminations only. Cap features swivel collar to adjust exhaust direction. Cap features an optional swivel base.

SIZE	ORDER #	STOCK #
3"	3PVP-HSC	810001080
4"	4PVP-HSC	810001144

### Ceiling Support/ Wall Thimble Cover

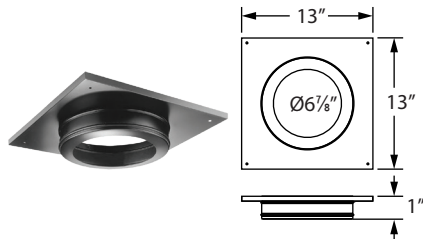

Decorative cover for ceiling support boxes and wall thimbles. Painted black. Use with reduction collar.

SIZE	ORDER #	STOCK #
3" - 4"	3PVP-WTC	810001098

### Reduction Collar

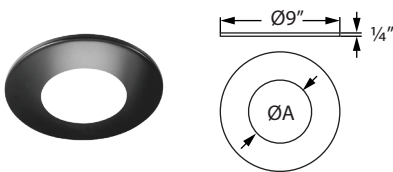

Reduces the center hole diameter in the Ceiling Support /Wall Thimble Cover to fit 3" or 4" pipe. Can be used as trim collar when penetrating a masonry chimney with PelletVent Pro. Painted black.

SIZE	ORDER #	STOCK #	A
3"	3PVP-RC	810001099	3 3/4"
4"	4PVP-RC	810001162	4 3/4"

### Chimney Adapter

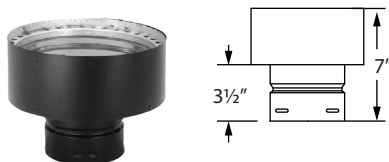

Use to transition between PelletVent Pro to existing chimney. Note: When connecting to DuraTech (DT) and DuraPlus (DP) chimney, also requires a DVL/DuraBlack Chimney Adapter.

SIZE	ORDER #	STOCK #
3" - 6"	3PVP-X6	810001101
3" - 7"	3PVP-X7	810008056
3" - 8"	3PVP-X8	810001102
4" - 6"	4PVP-X6	810001163
4" - 7"	4PVP-X7	810008057
4" - 8"	4PVP-X8	810001164

## BioFlex Pipe



Use when relining masonry chimney for use with biofuel appliances. Made of corrosion resistant stainless steel. Must be used with PelletVent Pro Male and Female Flex Adapters. Rigid pipe must be used when terminating system.

SIZE	3"		4"	
	ORDER #	STOCK #	ORDER #	STOCK #
15' FLEX	3PVP-15BF	810001165	4PVP-15BF	810001171
20' FLEX	3PVP-20BF	810001166	4PVP-20BF	810001172
25' FLEX	3PVP-25BF	810001167	4PVP-25BF	810001173
30' FLEX	3PVP-30BF	810001168	4PVP-30BF	810001174
35' FLEX	3PVP-35BF	810001169	4PVP-35BF	810001175
100' FLEX	3PVP-100BF	810001170	4PVP-100BF	810001176

## Prairie Termination Cap

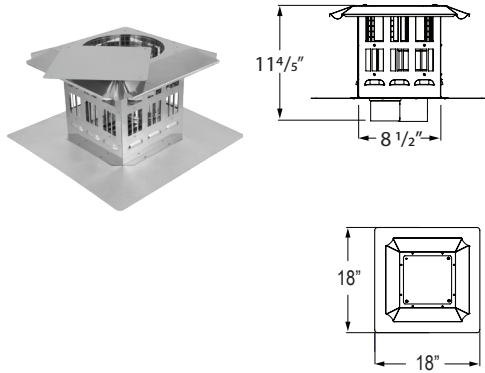

Use when installing a pellet insert into a multi-fuel pellet stove. This termination cap supplies both fresh air and vents exhaust. Lid pivots open for cleaning with three Removable screws and one rivet. Flex sold separately.

304SS and 316SS flex can be used when burning most fuels. If burning corn, corrosion resistant stainless steel bio-flex must be used as the exhaust vent. For fresh air, aluminum flex can be used. Stainless steel flex is not required for the fresh air supply unless specified by the appliance manufacturer.

SIZE	ORDER #	STOCK #	VENT EXHAUST	AIR INTAKE
3"	3PVP-VCT33	810006996	3"	3"
3" BLACK	3PVP-VCTB33	810005890	3"	3"
4"	4PVP-VCT34	810006997	4"	3"
4" BLACK	4PVP-VCTB34	810006998	4"	3"

## Pellet Vent Factory-Built Reline Kit



Use to reline an existing factory-built chimney or B vent. Can be used for wood, pellet, and biofuel burning appliances.

SIZE	304 Length		316 Length	
	ORDER #	STOCK #	ORDER #	STOCK #
3" Diameter 20' Length	3PVP304-20KFB	810009339	3PVP316-20KFB	810009340
4" Diameter 35' Length	4PVP304-35KFB	810009341	4PVP316-35KFB	810009342

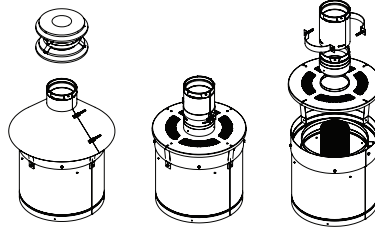

## Offset Chart

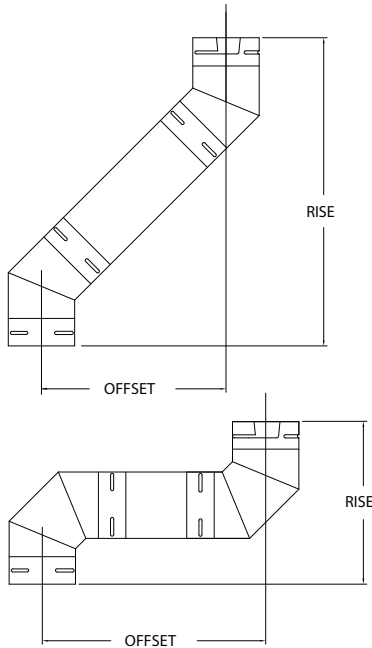

Elbow Angle from Vertical	Chimney Length Between Elbows	Ø3" Offset	Ø3" Rise	Ø4" Offset	Ø4" Rise
45°	0"	3 ¾"	10 ¼"	4 ¼"	12 ¼"
45°	6"	7"	13 ½"	7 ½"	15 ½"
45°	12"	11 ¼"	17 ¾"	11 ¾"	19 ¾"
45°	24"	19 ¾"	26 ¼"	20 ¼"	28 ¼"
45°	36"	28 ½"	34 ¾"	28 ¾"	36 ¾"
45°	24" + 24"	35 ½"	42"	36"	44"
45°	60"	45 ¼"	51 ¾"	45 ¾"	53 ¾"
45°	36" + 36"	52 ½"	59"	53"	61"
90°	0"	8 ¼"	9 ¾"	10"	11 ½"
90°	6"	12 ¾"	9 ¾"	14 ½"	11 ½"
90°	12"	18 ¾"	9 ¾"	20 ½"	11 ½"
90°	24"	30 ¾"	9 ¾"	32 ½"	11 ½"
90°	36"	42 ¾"	9 ¾"	44 ½"	11 ½"
90°	24" + 24"	53 ¼"	9 ¾"	55"	11 ½"
90°	60"	66 ¾"	9 ¾"	68 ½"	11 ½"
90°	36" + 36"	77 ¼"	9 ¾"	79"	11 ½"





BUILD FOR THE FUTURE

Customer Service and Support:

Airmate (USA).....	800.992.8368
Airmate (CAN) .....	888.735.5475
Ameriflow .....	800.252.8467
Amerivent (Retail).....	800.252.8467
Amerivent (Hearth & Wholesale) ....	800.423.4270
Amerivent (Support).....	800.748.0392
AMPCO (USA) .....	800.669.3269
AMPCO (CAN).....	888.735.5475
Duravent .....	800.835.4429
Hart & Cooley.....	800.433.6341
Hart & Cooley (Support) .....	800.748.0392
Heatfab (USA).....	800.772.0739
Heatfab (CAN) .....	800.848.2149
Lima.....	800.423.4270
Milcor .....	800.774.5240
Portals Plus.....	800.774.5240
RPS.....	800.624.8642
Security Chimney (USA).....	800.361.4909
Security Chimney (CAN) .....	800.667.3387
Selkirk (USA) Residential .....	800.992.8368
Selkirk (USA) Commercial.....	800.848.2149
Selkirk (USA) Support.....	800.748.0392
Selkirk (CAN) .....	888.735.5475

Manufacturing & Distribution Centers:

CANADA	
Nobel, ON	Manufacturing
Laval, QC	Manufacturing
Prescott, ON	Distribution
USA	
Grand Rapids, MI	Center of Excellence
Dallas, TX	Distribution
Englewood, OH	Distribution
Huntsville, AL	Manufacturing & Distribution
Mira Loma, CA	Distribution
Nampa, ID	Manufacturing & Distribution
Turner Falls, MA	Manufacturing & Distribution
Vacaville, CA	Manufacturing
MEXICO	
Ojinaga, MX	Manufacturing
Mexicali, MX	Manufacturing

Corporate Headquarters:

Duravent Group  
 28 W. Adams, Suite 1810  
 Detroit, MI 48226  
 Tel: 800.835.4429  
 Email: [info@duraventgroup.com](mailto:info@duraventgroup.com)  
[www.duraventgroup.com](http://www.duraventgroup.com)

duravent™

**duravent**™  
GROUP

BUILD FOR THE FUTURE

[www.duraventgroup.com](http://www.duraventgroup.com)

