













SPF Series

23" Plug-in Infrared Electric Firebox

SPF2320L-IR

Features

-  **Flame Effect**
High-contrast flames with 3 brightness settings feature improved brightness and character for a captivating, lifelike effect.
-  **Inner Glow Logs**
Embers glow from within the realistic hand-crafted logs.
-  **Infrared Heating**
Powerful infrared heater features a safe element that provides on-demand heat for up to 1,000 square feet.
-  **LED Lighting**
Flame and lights use brilliant, low-energy LED's that require zero maintenance.
-  **Thermostat Display**
View the set temperature on the digital display (°C / °F).
-  **Multi-function Remote**
Control the flame, heat and thermostat from the comfort of your chair.
-  **Timer**
Set it and forget it, with timer settings of 1-8 hours.
-  **All-season Flames**
Enjoy the unique charm of a fireplace 365 days a year using the flames without the heat.
-  **Cool-touch Glass**
Glass remains cool making it safe for any location and any user.
-  **Low Carbon Footprint**
The most sustainable fireplace option; no emissions and 100% efficient.
-  **Just Plug It In**
Simply plug into any standard household outlet for instant ambiance.

Warms up to **1,000** sq. ft.



Also available in Acrylic Crystals: SPF2320C-IR



Multi-function Remote

120 Volts | 1,400 Watts | 5,000 BTU

Model #	Description	Lbs / Kg	UPC	Wty. [†]	Carton Dimensions (WxHxD)		Cube	
					Inches	cm	ft ³	m ³
SPF2320L-IR	23" Infrared Electric Firebox - Logs	28.8 / 13.1	781052 130982		24-7/8 x 18-3/4 x 10-1/4	63.2 x 47.5 x 26.2	3.0	0.1
SPF2320C-IR	23" Infrared Electric Firebox - Acrylic Crystals	28.8 / 13.1	781052 130999		24-7/8 x 18-3/4 x 10-1/4	63.2 x 47.5 x 26.2	3.0	0.1

Specifications, finishes and dimensions are subject to change. [†]Limited warranty. ©2020 Glen Dimplex Americas

SE-513-R00-012420



SPF Series

23" Plug-in Infrared Electric Firebox

SPF2320L-IR

Installation Dimensions:

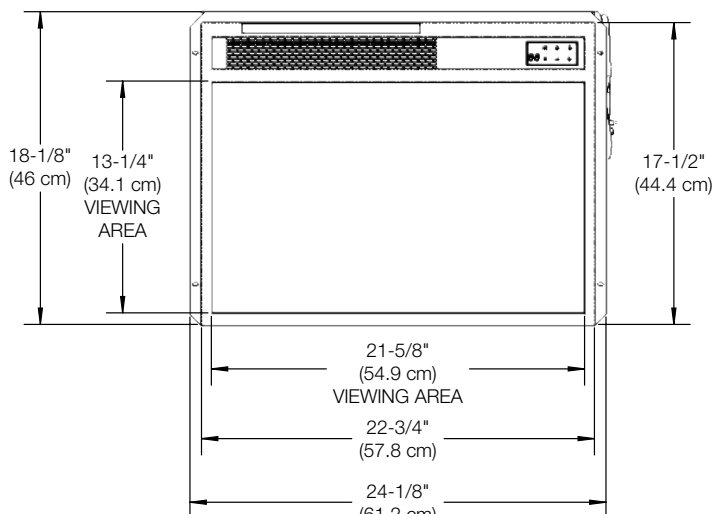
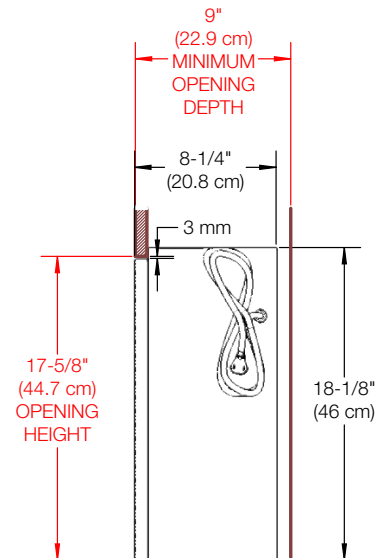
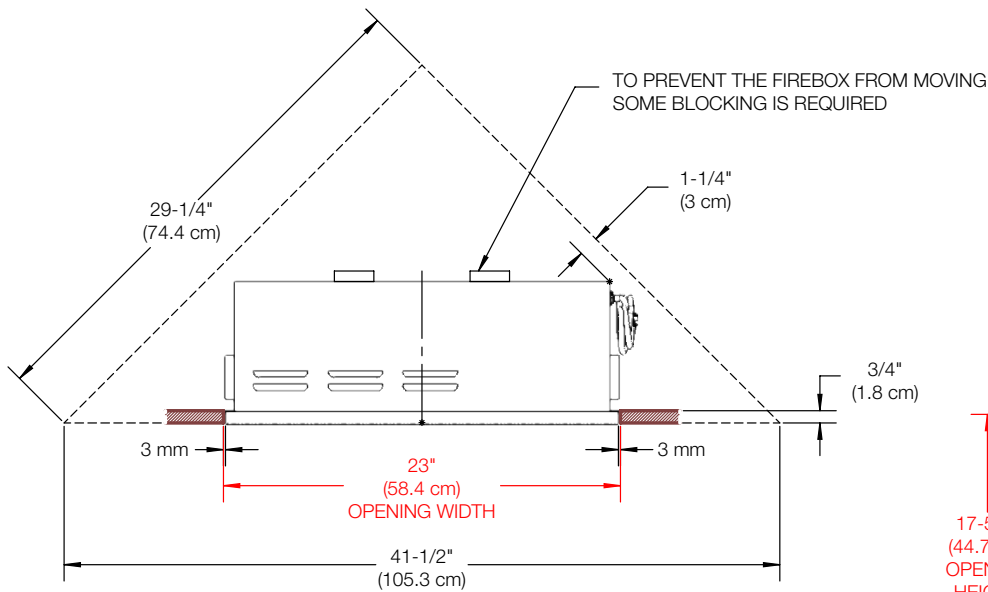

FIREBOX IS MEANT FOR FURNITURE INSTALLATION. CANNOT BE DIRECTLY BUILT INTO A WALL.

