

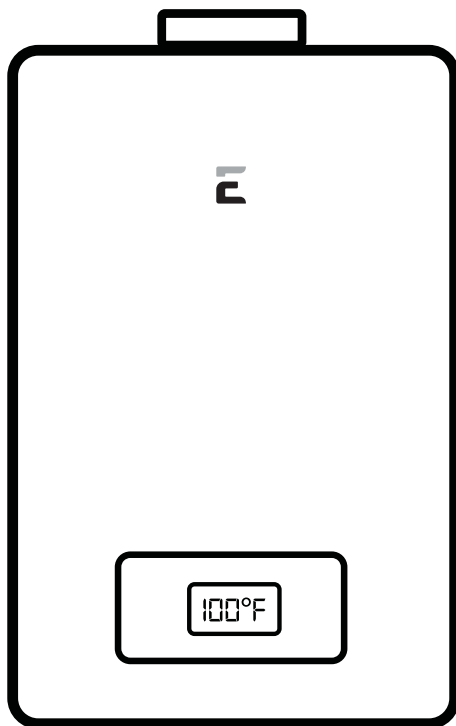

6GB BUILDER SERIES INDOOR MANUAL

WHOLE HOME TANKLESS HOT WATER HEATER
INSTALLATION, USE AND CARE INSTRUCTIONS



Whole Home



Mid Size Home



Town Home



Apartment/Condos



Wash Down



Tiny House



Cabins







Office





WARNING: If the information in these instructions is not followed exactly, a fire or explosion may result causing property damage, personal injury or death.





- **Do not store or use gasoline or other flammable vapors and liquids in the vicinity of this or any other appliances.**
- **WHAT TO DO IF YOU SMELL GAS**
 - **Do not try to light any appliances.**
 - **Do not touch any electrical switch; do not use any phone in your building.**
 - **Immediately call your gas supplier from a neighbor's phone. Follow the gas supplier's instructions.**
 - **If you cannot reach your gas supplier, call the fire department.**
- **Installation and service must be performed by a qualified installer, service agency or the gas supplier.**







PLEASE NOTE: 6GB IS FOR INDOOR PERMANENT INSTALLATIONS ONLY. THIS MANUAL AND ALL ECCOTEMP CONTENT IS SUBJECT TO CHANGE WITHOUT NOTICE. PLEASE VISIT WWW.ECCOTEMP.COM/SUPPORT FOR MORE INFORMATION.

| | | | | | |
|--|--|--|---|---|--|
|  Ecotemp Systems, LLC 315-A Industrial Road Summerville, SC 29483 866-356-1992 | | | |    | |
| AUTOMATIC INSTANTANEOUS WATER HEATER | | | | | |
| MODEL #: | 6GB-ING | Maximum Input Rating (Btu per hour): | 145,000 | | |
| SERIAL #: | | Minimum Input Rating (Btu per hour): | 18,000 | | |
| TYPE GAS: | NATURAL GAS ONLY | Minimum Inlet Gas Pressure: | 3.5" W.C. (0.87kPa) | | |
| Voltage: | 120 Volts | Maximum Inlet Gas Pressure: | 10.5" W.C. (2.61 kPa) | | |
| Frequency: | 60 Hz | Manifold Pressure: | 3.29" W.C. (0.82kPa) | | |
| Amps: | Less than 10 Amperes | Maximum Working Pressure: | 150 psi | | |
| Recovery Rating: | As used in this standard, the quantity of water obtained by multiplying the manufacturer's input rating in Btu per hour by the thermal efficiency and dividing the product by 825 Btu per gallon. This is based on a 100°F (37.8°C) temperature rise, and a nominal specific heat for water of 8.25 Btu per gallon per degree F. | | | | |
| | Not recommended in excess of 2,000 ft. above sea level. | | Category III Type B Water Heater | | |
| CANADIAN HIGH ALTITUDE RATING | | | | | |
| Altitude | 0-2000 feet | | | | |
| Input (Btu/hr) | 145,000 | | | | |
| Manifold pressure (in. w.c.) | 3.5 | | | | |
| CSA/ANSI Z21.10.3 + CSA 4.3-2021 | | | SUITABLE FOR WATER (POTABLE) HEATING ONLY | | |
| FOR YOUR SAFETY Do not store or use gasoline or other flammable vapors and liquids in the vicinity of this or any other appliance. | | This appliance must be installed in accordance with local codes or, in the absence of local codes, the National Fuel Gas Code, ANSI Z223.1/NFPA 54 or the CSA B149.1, Natural Gas and Propane Installation Code. | | | |
| The unit must be installed on a fire retardant area, and must be away from all combustible materials. Clearance should be 1.75 ft to the left and right side of combustible materials, and 6.75 ft to the front. | | | | | |
| Open on three sides and an overhead clearance of 36" | | | | | |
| The temperature and pressure relief valve provided by the manufacturer shall be installed at the time of installation of the heater in the location specified by the manufacturer. Local codes shall govern installation of relief devices. For safe operation of the water heater, the relief valve must not be removed or plugged. | | | | | |
| INDOOR USE ONLY | | | | | |

| | | | | | |
|--|--|--|---|---|--|
|  Ecotemp Systems, LLC 315-A Industrial Road Summerville, SC 29483 866-356-1992 | | | |    | |
| AUTOMATIC INSTANTANEOUS WATER HEATER | | | | | |
| MODEL #: | 6GB-ILP | Maximum Input Rating (Btu per hour): | 145,000 | | |
| SERIAL #: | | Minimum Input Rating (Btu per hour): | 18,000 | | |
| TYPE GAS: | LIQUID PROPANE ONLY | Minimum Inlet Gas Pressure: | 8.0" w.c (1.99 kPa) | | |
| Voltage: | 120 Volts | Maximum Inlet Gas Pressure: | 13.0" w.c (3.23 kPa) | | |
| Frequency: | 60 Hz | Manifold Pressure: | 5. 2" W.C. (1.27kPa) | | |
| Amps: | Less than 10 Amperes | Maximum Working Pressure: | 150 psi | | |
| Recovery Rating: | As used in this standard, the quantity of water obtained by multiplying the manufacturer's input rating in Btu per hour by the thermal efficiency and dividing the product by 825 Btu per gallon. This is based on a 100°F (37.8°C) temperature rise, and a nominal specific heat for water of 8.25 Btu per gallon per degree F. | | | | |
| | Not recommended in excess of 2,000 ft. above sea level. | | Category III Type B Water Heater | | |
| CANADIAN HIGH ALTITUDE RATING | | | | | |
| Altitude | 0-2000 feet | | | | |
| Input (Btu/hr) | 145,000 | | | | |
| Manifold pressure (in. w.c.) | 5.1 | | | | |
| CSA/ANSI Z21.10.3 + CSA 4.3-2021 | | | SUITABLE FOR WATER (POTABLE) HEATING ONLY | | |
| FOR YOUR SAFETY Do not store or use gasoline or other flammable vapors and liquids in the vicinity of this or any other appliance. | | This appliance must be installed in accordance with local codes or, in the absence of local codes, the National Fuel Gas Code, ANSI Z223.1/NFPA 54 or the CSA B149.1, Natural Gas and Propane Installation Code. | | | |
| The unit must be installed on a fire retardant area, and must be away from all combustible materials. Clearance should be 1.75 ft to the left and right side of combustible materials, and 6.75 ft to the front. | | | | | |
| Open on three sides and an overhead clearance of 36" | | | | | |
| The temperature and pressure relief valve provided by the manufacturer shall be installed at the time of installation of the heater in the location specified by the manufacturer. Local codes shall govern installation of relief devices. For safe operation of the water heater, the relief valve must not be removed or plugged. | | | | | |
| INDOOR USE ONLY | | | | | |

| | | | | | |
|--|---|--|---|---|--|
|  Ecotemp Systems, LLC 315-A Industrial Road Summerville, SC 29483 866-356-1992 | | | |    | |
| CHAUFFE-EAU INSTANTANÉ AUTOMATIQUE | | | | | |
| MODÈLE #: | 6GB-ING | Puissance Maximum d'Entrée | 145,000 | | |
| SÉRIE #: | | Puissance Minimum d'Entrée | 18,000 | | |
| TYPE DE GAZ: | GAZ NATUREL SEULEMENT | Pression minimale d'arrivée de gaz | 3.5" W.C. (0.87kPa) | | |
| Tension: | 120 Volts | Pression maximale d'arrivée de gaz | 10.5" W.C. (2.61 kPa) | | |
| Fréquence: | 60 Hz | Pression d'admission | 3.29" W.C. (0.82kPa) | | |
| Amperes: | Moins de 10 Amperes | Pression de travail maximale | 150 psi | | |
| Note de Récupération: | Tel qu'utilisé dans la présente norme, la quantité d'eau obtenue en multipliant la valeur nominale d'entrée du fabricant en Btu par heure par l'efficacité thermique et en divisant le produit par 825 BTU par gallon. Ceci est basé sur un élévation de température de 100°F, et une spécification thermique nominale de l'eau de 8.25 BTU par gallon par degré F. | | | | |
| | Non recommandé à plus de 2000 pieds au-dessus du niveau de la mer. | | Chauffe-eau de Catégorie III Type B | | |
| CANADIENNE ALTITUDE NOTE HAUT | | | | | |
| Altitude | 0-2000 feet | | | | |
| Entrée (BTU / h) | 145,000 | | | | |
| La pression d'admission (en. W.C.) | 3.5 | | | | |
| ANSI Z21.10.3-2014/CSA 4.3-2014CAN 2-17 STANDARD | | | ADAPTÉ À L'EAU (POTABLE) CHAUFFAGE SEUL | | |
| POUR VOTRE SÉCURITÉ Ne pas entreposer ou utiliser de l'essence ou d'autres vapeurs et liquides inflammables à proximité de cet appareil ou de tout autre appareil. | | Cet appareil doit être installé conformément aux codes locaux ou, en l'absence de codes locaux, le National Fuel Gas Code, ANSI Z223.1 / NFPA 54 ou le CSA B149.1, gaz naturel et propane Code d'installation. | | | |
| L'appareil doit être installé sur une zone de retardateur de feu, et doit être loin de tous matériaux combustibles. Jeu doit être de 1,75 m sur le côté gauche et à droite de matériaux combustibles, et de 6,75 m à l'avant. | | | | | |
| Ouvret sur trois côtés et une hauteur libre de 36" | | | | | |
| Le soupape de sûreté température et de pression fournie par le fabricant doit être installé au moment de l'installation du chauffe-eau à l'emplacement indiqué par le fabricant. Les codes locaux régissent l'installation de dispositifs de sécurité. Pour une opération sûre de l'appareil de chauffage de l'eau, le soupape de sûreté ne doit pas être enlevé ou branché. | | | | | |
| UTILISATION EN INTÉRIEUR UNIQUEMENT | | | | | |

| | | | | | |
|--|--|--|---|---|--|
|  Ecotemp Systems, LLC 315-A Industrial Road Summerville, SC 29483 866-356-1992 | | | |    | |
| CHAUFFE-EAU INSTANTANÉ AUTOMATIQUE | | | | | |
| MODÈLE #: | 6GB-ILP | Puissance Maximum d'Entrée: | 145,000 | | |
| SÉRIE #: | | Puissance Minimum d'Entrée: | 18,000 | | |
| TYPE DE GAZ: | PROPANE LIQUIDE SEULEMENT | Pression minimale d'arrivée de gaz: | 8.0" w.c (1.99 kPa) | | |
| Tension: | 120 Volts | Pression maximale d'arrivée de gaz: | 13.0" w.c (3.23 kPa) | | |
| Fréquence: | 60 Hz | Pression d'admission: | 5. 2" W.C. (1.27kPa) | | |
| Amperes: | Moins de 10 Amperes | Pression de travail maximale: | 150 psi | | |
| Note de Récupération: | Tel qu'utilisé dans la présente norme, la quantité d'eau obtenue en multipliant la volumétrie d'entrée du fabricant en Btu par heure par l'efficacité thermique et en divisant le produit par 825 BTU par gallon. Ceci est basé sur un élévation de température de 100°F, et une spécification thermique nominale de l'eau de 8.25 BTU par gallon par degré F. | | | | |
| | Non recommandé à plus de 2000 pieds au-dessus du niveau de la mer. | | Chauffe-eau de Catégorie III Type B | | |
| CANADIENNE ALTITUDE NOTE HAUT | | | | | |
| Altitude | 0-2000 feet | | | | |
| Entrée (BTU / h) | 145,000 | | | | |
| La pression d'admission (en. W.C.) | 5.1 | | | | |
| ANSI Z21.10.3-2014/CSA 4.3-2014CAN 2-17 STANDARD | | | ADAPTÉ À L'EAU (POTABLE) CHAUFFAGE SEUL | | |
| POUR VOTRE SÉCURITÉ Ne pas entreposer ou utiliser de l'essence ou d'autres vapeurs et liquides inflammables à proximité de cet appareil ou de tout autre appareil. | | Cet appareil doit être installé conformément aux codes locaux ou, en l'absence de codes locaux, le National Fuel Gas Code, ANSI Z223.1 / NFPA 54 ou le CSA B149.1, gaz naturel et propane Code d'installation. | | | |
| L'appareil doit être installé sur une zone de retardateur de feu, et doit être loin de tous matériaux combustibles. Jeu doit être de 1,75 m sur le côté gauche et à droite de matériaux combustibles, et de 6,75 m à l'avant. | | | | | |
| Ouvret sur trois côtés et une hauteur libre de 36" | | | | | |
| Le soupape de sûreté température et de pression fournie par le fabricant doit être installé au moment de l'installation du chauffe-eau à l'emplacement indiqué par le fabricant. Les codes locaux régissent l'installation de dispositifs de sécurité. Pour une opération sûre de l'appareil de chauffage de l'eau, le soupape de sûreté ne doit pas être enlevé ou branché. | | | | | |
| UTILISATION EN INTÉRIEUR UNIQUEMENT | | | | | |

Use & Care Manual

With Installation Instructions for the Installer

| APPLICATION |
|-------------|
| Residential |

| INSTALLATION |
|--------------|
| Indoor |

| BTU'S |
|---------|
| 145,000 |

| FLOW RATE |
|-----------|
| 6GPM |

Tankless Water Heater

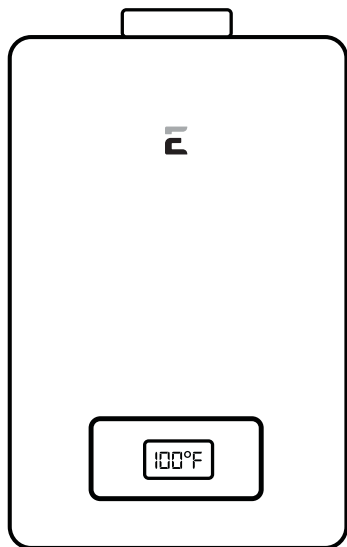

WARNING: This water heater may not be suitable for use in manufactured (mobile) homes! Please check local code restrictions pertaining to permanent/fixed installations in manufactured homes in your area.

The purpose of this manual is twofold: one, to provide the installer with the basic directions and recommendations for the proper installation and adjustment of the water heater; and two, to the owner-operator, to explain the features, operation, safety precautions, maintenance and troubleshooting of the water heater. This manual also includes a parts list.

It is imperative that all persons who are expected to install, operate or adjust this water heater read the instructions carefully so they may understand how to perform these operations. If you don't understand these instructions or any terms within it, seek professional advice.

⚠ Any questions regarding the operation, maintenance, service or warranty of this water heater should be directed to the seller from whom it was purchased. If additional information is required, refer to the section on if you need service.

⚠ Do not destroy this manual. Please read carefully and keep in a safe place for future reference.

⚠ Recognize this symbol as an indication of Important Safety Information!

⚠ California Proposition 65 Warning: This product contains chemicals known to the State of California to cause cancer, birth defects or other reproductive harm.

⚠ **WARNING:** If the information in these instructions is not followed exactly, a fire or explosion may result causing property damage, personal injury or death.

⚠ FOR YOUR SAFETY!

Improper installation, adjustment, alteration, service or maintenance can cause property damage, personal injury, or death. Refer to this manual. Installation and service must be performed by a qualified installer, service agency or the gas supplier.

DO NOT store or use gasoline or other flammable vapors or liquids or other combustible materials in the vicinity of this or any other appliance. To do so may result in an explosion or fire.

WHAT TO DO IF YOU SMELL GAS

- **DO NOT** try to light any appliances.
- **DO NOT** touch any electrical switch; do not use any phone in your building.
- Immediately call your gas supplier from a neighbor's phone. Follow the gas supplier's instructions.
- If you cannot reach your gas supplier, call the fire department.
- **DO NOT** return to your home until authorized by the gas supplier or fire department.

PLEASE NOTE: 6GB IS FOR INDOOR PERMANENT INSTALLATIONS ONLY. THIS MANUAL AND ALL ECCOTEMP CONTENT IS SUBJECT TO CHANGE WITHOUT NOTICE. PLEASE VISIT WWW.ECCOTEMP.COM/SUPPORT FOR MORE INFORMATION.

Safety Information

Safety Precautions 6-9

6GB Installation Instructions

Location 10

Venting 11-12

Performance Features 13

Water Connections 15

Pressure/Gas Leak Testing 16

Relief Valve 17

Automatic Drainage 18

Electrical Connection 18

Operating Instructions

Start Instructions 19

Normal Operation 20

Care and Cleaning

Anti-Freezing 20

Maintenance 21

Troubleshooting Tips

Temperature/Water 22

Error Code Guide 23-24

Temperature Settings 25

Warranty 26-27

FOR YOUR RECORDS

Write the model and serial numbers here:



You can find them on a label on the water heater and/or packaging.

Staple sales slip or canceled check here.

Proof of the original purchase date is needed to obtain service under the warranty.

READ THIS MANUAL

Inside you will find many helpful hints on how to use and maintain your water heater properly. A little preventive care on your part can save you time and money over the life of your water heater. You'll find many answers to common problems in the Troubleshooting Guide. If you review the chart of Troubleshooting Tips first, you may not need to call for service.

**READ THE SAFETY INFORMATION**

Your safety and the safety of others are very important. There are many important safety messages in this manual and on your water heater. Always read and obey all safety messages. This is the safety alert symbol. Recognize this symbol as an indication of Important Safety Information! This symbol alerts you to potential hazards that can kill or hurt you and others.

All safety messages will follow the safety alert symbol and either the word "**DANGER**", "**WARNING**", "**CAUTION**" or "**NOTICE**".

These words mean:

DANGER - An imminently hazardous situation that will result in death or serious injury.

WARNING - A potentially hazardous situation that could result in death or serious injury and/or damage to property.

CAUTION - A potentially hazardous situation that may result in minor or moderate injury.

NOTICE: Attention is called to observe a specified procedure or maintain a specific condition.

IMPORTANT SAFETY INFORMATION READ ALL INSTRUCTIONS BEFORE USING

Be sure to read and understand the entire Use and Care Manual before attempting to install or operate this water heater. It may save you time and money. Pay particular attention to the Safety Instructions. Failure to follow these warnings could result in serious bodily injury or death. Should you have problems understanding the instructions in this manual, or have any questions, **STOP**, and get help from a qualified service technician, or the local gas utility.

⚠ DANGER!



PROPERLY INSTALL WATER HEATER

Failure to properly install the water heater **INDOORS** as outlined in the Installation. Instructions in this manual can result in unsafe operation of the water heater. To avoid the risk of fire, explosion, or asphyxiation from carbon monoxide, never operate this water heater unless it is installed properly and has an adequate air supply for proper operation. Be sure to inspect the flue terminal for proper installation at initial start-up; and at least annually thereafter. Refer to the Care and Cleaning section of this manual for more information regarding flue terminal inspection.



⚠ WARNING!!

Gasoline, as well as other flammable materials and liquids (adhesives, solvents, paint thinners etc.), and the vapors they produce are extremely dangerous. **DO NOT** handle, use or store gasoline or other flammable or combustible materials anywhere near or in the vicinity of a water heater or any other appliance. Be sure to read and follow the labels on the water heater, as well as the warnings printed in this manual. Failure to do so can result in property damage, bodily injury or death.

| CAUTION | |
|--|--|
| | |
| <p>⚠ Vapors from flammable liquids will explode and catch fire causing death or severe burns.</p> <p>Do not use or store flammable products such as gasoline, solvents or adhesives in the same room or area near the water heater.</p> <p>Keep flammable products:</p> <ol style="list-style-type: none"> 1. Far away from heater 2. In approved containers 3. Tightly closed 4. Out of children's reach | <p>Water heater has a main burner flame. The main burner flame</p> <ol style="list-style-type: none"> 1. Can come on at any time and 2. Will ignite flammable vapors. <p>Vapors:</p> <ol style="list-style-type: none"> 1. Cannot be seen 2. Are heavier than air 3. Go a long way on the floor 4. Can be carried from other rooms to the main burner flame by air currents. |
| <p>Installation:</p> <p>Do not install water heater where flammable products will be stored or used unless the main burner flame is at least 18" above the floor. This will reduce, but not eliminate, the risk of vapors being ignited by the main burner flame.</p> | |
| <p>Read and follow water heater warnings and instructions. If owners manual is missing, contact the retailer or manufacturer.</p> | |

IMPORTANT SAFETY INFORMATION

READ ALL INSTRUCTIONS BEFORE USING

⚠ DANGER!

WATER TEMPERATURE SETTING



Safety and energy conservation are factors to be considered when selecting the water temperature setting. Water temperatures above 125°F can cause severe burns or death from scalding. The thermostat is adjusted to its lowest temperature position when shipped from the factory. Be sure to read and follow the warnings outlined on the label pictured below.

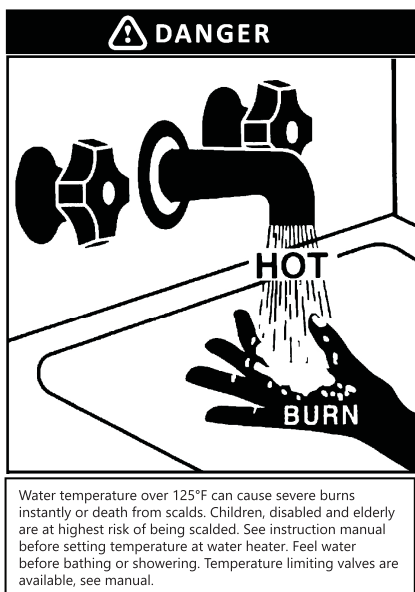

Time/Temperature Relationship in Scalds

| Water Temperature | Time To Produce a Serious Burn |
|-------------------|--------------------------------|
| 120°F | More than 5 minutes |
| 125°F | 1 1/2 to 2 minutes |
| 130°F | About 30 seconds |
| 135°F | About 10 seconds |
| 140°F | Less than 5 seconds |
| 145°F | Less than 3 seconds |
| 150°F | About 1 1/2 seconds |
| 155°F | About 1 second |

Table courtesy of Shriners Burn Institute

The chart shown above may be used as a guide in determining the proper water temperature for your home

⚠ DANGER: Households with small children, disabled, or elderly persons may require a 120°F. or lower temperature setting to prevent contact with "HOT" water.

Maximum water temperature occurs while burner is on. To find water temperature being delivered, turn on a hot water faucet and place a thermometer in the water stream and read the thermometer.

The temperature of the water at the outlet of the water heater can be regulated by setting the temperature on Remote Control. The remote control was set at 110°F before it was shipped from the factory.

The illustration to the bottom left illustrates the Remote Control and how to adjust the water temperature.

NOTICE: When this water heater is supplying general purpose hot water requirements for use by individuals, a thermostatically controlled mixing valve for reducing point of use water temperature is recommended to reduce the risk of scald injury. Contact a licensed plumber or the local plumbing authority for further information.

NOTICE: The factory recommended operating temperatures are between 90°F and 140°F.



⚠️ DANGER!

NATURAL GAS AND LIQUEFIED PETROLEUM MODELS

Both LP and natural gas have an odorant added to aid in detecting a gas leak. Some people may not physically be able to smell or recognize this odorant. If you are unsure or unfamiliar with the smell of LP or natural gas, ask the gas supplier. Other conditions, such as "odorant fade", which causes the odorant to diminish in intensity, can also hide or camouflage a gas leak. Always check with commercial leak detector or soapy water.

- Gas detectors are recommended in LP and natural gas applications and their installation should be in accordance with the detector manufacturer's recommendations and/or local laws, rules, regulations or customs.
- Water heaters utilizing LPG are different from natural gas models. A natural gas water heater will not function safely on LPG and vice versa.
- No attempt should ever be made to convert the water heater from natural gas to LPG. To avoid possible equipment damage, personal injury or fire, do not connect the water heater to a fuel type not in accordance with the unit data plate; propane for propane units and natural gas for natural gas units. These units are not certified for any other fuel type.
- LP water heaters should not be installed below grade (for example, in a basement) if such installation is prohibited by federal, state and/or local laws, rules, regulations or customs.
- Propane or LPG must be used with great caution. It is heavier than air and will collect first in lower areas making it hard to detect at nose level.
- Before attempting to light the water heater, make sure to look and smell for gas leaks. Use a soapy solution to check all gas fittings and connections. Bubbling at a connection indicates a leak that must be corrected. When smelling to detect a gas leak, be sure to sniff near the floor also.
- It is recommended that more than one method, such as soapy solution, gas detectors, etc., be used to detect leaks in gas applications.

Notice: If a gas leak is present or suspected:

- **DO NOT attempt to find the cause yourself.**
- **DO NOT try to light any appliances.**
- **DO NOT touch any electrical switch.**
- **DO NOT use any phone in your building.**
- **Leave the house immediately and make sure your family and pets leave also.**
- **Leave the doors open for ventilation and contact the gas supplier, a qualified service agency or the fire department.**
- **Stay away from the house (or building) until the service call has been made, the leak is corrected and a qualified agency has determined the area to be safe.**

IMPORTANT SAFETY INFORMATION

READ ALL INSTRUCTIONS BEFORE USING

WARNING!

For your safety, the information in this manual must be followed to minimize the risk of fire or explosion, electric shock, or to prevent property damage, personal injury, or loss of life.



FOR INSTALLATIONS IN THE STATE OF CALIFORNIA

California Law requires that residential water heaters must be braced, anchored or strapped to resist falling or horizontal displacement due to earthquake motions. For residential water heaters up to 52 gallon capacity, a brochure with generic earthquake bracing instructions can be obtained from: Office of the State Architect, 400 P Street, Sacramento, CA 95814 or you may call 916-445-8100 or ask a water heater dealer.

However, applicable local codes shall govern installation. For residential water heaters of a capacity greater than 52 gallons or tankless style, consult the local building jurisdiction code for acceptable bracing procedures.



SAFETY PRECAUTIONS

Have the installer show you the location of the gas shut-off valve and how to shut it off if necessary. Turn off the manual shut-off valve if the water heater has been subjected to overheating, fire, flood, physical damage or if the gas supply fails to shut off.

- Read this manual entirely before installing or operating the water heater.
- Use this water heater only for its intended purpose as described in this Use and Care Manual.
- Be sure your water heater is properly installed in accordance with local codes and the provided installation instructions.
- Part of your water heater unless it is specifically recommended in this manual. All other servicing should be referred to a qualified technician.



READ AND FOLLOW THIS SAFETY INFORMATION CAREFULLY.

SAVE THESE INSTRUCTIONS

This water heater must be installed in accordance with these instructions, local codes, utility company requirements, and/or in the absence of local codes, use the latest edition of the American National Standard/National Fuel Gas Code. A copy can be purchased from either the American Gas Association, 400 North Capitol Street Northwest, Washington, DC 20001 as ANSI standard Z223.1 or National Fire Protection Association, 1 Batterymarch Park, Quincy, MA 02269 as NFPA 54. In Canada, the latest edition of the CSA B149.1 Natural Gas and Propane Installation, and the Canadian Electrical Code, CSA. C22.1Part1, in the absence of local codes.

INSTALLING THE 6GB WATER HEATER

Location

This water heater is for **INDOOR** installation **ONLY!**

Make sure before installation that the gas type you will use is the same type on the data plate.

The water heater unit should be installed by professionals from your local gas company. Please don't attempt installation by yourself. Improper installation may cause failure or dangerous conditions such as gas leaking or explosion.

This water heater is an **INDOOR** model and must be mounted on a vertical wall. It must not be installed outdoors or in a confined space. The water heater should be installed close to the most frequently used outlet and its position chosen with safety and service in mind.

Make sure people (particularly children, disabled, and elderly) will not touch the hot water outlet or the flue terminal. The flue terminal and air inlet must be clear of obstruction and shrubbery.

If installed in a public corridor, please assure that the surrounding area is free of debris, obstruction and flammable materials.

The unit must be installed on a fire retardant area, and must be away from all flammable materials. Clearance should be 1.75 ft to the left and right side of flammable materials, and 6.75 ft to the front.

The unit should be installed in open area where strong currents are not prevalent

This unit is of high power and will consume a lot of oxygen when working, so the installation area must be well ventilated, and air in and out of the area has no blockage.

The **INDOOR** unit should not be installed in a corridor with rooms on the both sides or in the closed corridor.

Take measures to avoid direct wind, rain and snow. The installation area should be constructed of fire retardant materials. The power socket connecting the water heater should be properly grounded

The water heater must be located so it is not subject to physical damage, for example, by moving vehicles, area flooding, etc.

The water heater must be installed vertically with the water, gas, and power connections on the underside, pointing toward the ground.

Failure to properly install the water heater **INDOORS** as outlined in this manual can result in unsafe operation.

Hot and cold water lines should be insulated to conserve water and energy.

DO NOT install water heater where subject to vibrations.

DO NOT install the water heater in Recreational Vehicles, Mobile Homes, Boats and other Watercraft.

DO NOT install the water heater near vents for heating or cooling. A minimum of 4 feet should be maintained.

If the clearances stated on the Instruction/Warning Label, located on the front panel of the heater differ, install the water heater according to the clearances stated on the label.

⚠ WARNING: Combustible construction refers to adjacent walls and ceilings and should not be confused with combustible or flammable products and materials. Combustible and/or flammable products and materials should never be stored in the vicinity of this or any gas appliances.

⚠ WARNING: The 6GB is to be installed INDOORS only. In some climates the ambient air temperature will fall below the temperature in which water freezes 32°F / 0°C. DO NOT use the 6GB water heater in unsafe freezing conditions because it could damage the water heater or cause other property damage. Make sure that all components and controls are suitable for use in the current temperature before using.

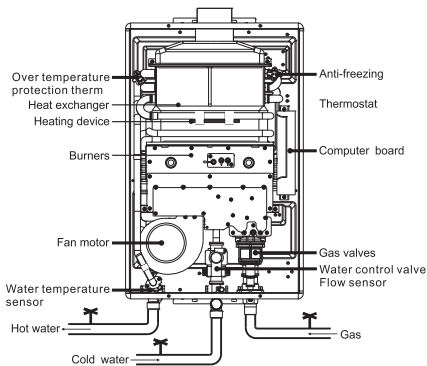

INSTALLING THE 6GB WATER HEATER

Proper operation of the water heater requires air for combustion and ventilation. Provisions for combustion and ventilation air must comply with referenced codes and standards.

Combustion and Ventilation Air

This water heater is for **INDOOR** installation **ONLY**.

It must **NOT** be installed outdoors or in a confined space.

Corrosive Atmospheres

NOTICE: The water heater should not be installed near an air supply containing halogenated hydrocarbons.

The air in beauty shops, dry cleaning establishments, photo processing labs, and storage areas for liquid and powdered bleaches or swimming pool chemicals often contain such halogenated hydrocarbons.

An air supply containing halogenated hydrocarbons may be safe to breathe, but when it passes through a gas flame corrosive elements are released that will shorten the life of any gas burning appliance.

Propellants from common spray cans or gas leaks from A/C and refrigeration equipment are highly corrosive after passing through a flame.

The water heater warranty is voided when failure of the heater is due to operation in a corrosive atmosphere.

Inspect Shipment

Inspect the water heater for possible damage. Check the markings on the rating plate of the water heater to be certain the type of gas supplied corresponds to the water heater requirements. Verify all included parts are present (see below).

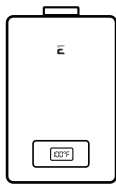

Gas Water Heater



Instruction Manual



Hardware Pack

PLEASE NOTE: 6GB IS FOR INDOOR PERMANENT INSTALLATIONS ONLY. THIS MANUAL AND ALL ECCOTEMP CONTENT IS SUBJECT TO CHANGE WITHOUT NOTICE. PLEASE VISIT WWW.ECCOTEMP.COM/SUPPORT FOR MORE INFORMATION.

CLEARANCES FOR INDOOR WATER HEATER INSTALLATION LOCATIONS

- Clearance in accordance with local installation codes and the requirements of the gas supplier.
- A vent shall not terminate directly above a sidewalk or paved driveway that is located between two single family dwellings.
- This water heater is strictly forbidden to be installed outdoors and in the bathroom.
- The water heater shall not be installed under the exhaust fan of the exhaust fan or range hood.
- There shall be no other gas appliances near the installation of the water heater, and there shall be no flammable gasses, liquid, etc. around it.
- Installation of **INDOOR** water heaters should avoid the impact of others people's lives due to exhaust and noise.
- The water heater must be installed in a well ventilated area (eg. open balcony, patio).
- The distance between the water heater and the surrounding wall (mm).

VENT TERMINATION CLEARANCES FOR NON-DIRECT VENT INSTALLATIONS IN THE US AND CANADA

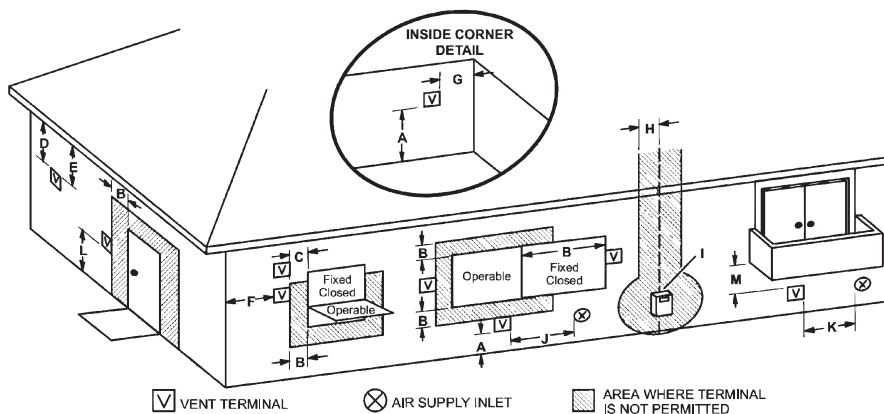

PLEASE NOTE: 6GB IS FOR INDOOR PERMANENT INSTALLATIONS ONLY. THIS MANUAL AND ALL ECCOTEMP CONTENT IS SUBJECT TO CHANGE WITHOUT NOTICE. PLEASE VISIT WWW.ECCOTEMP.COM/SUPPORT FOR MORE INFORMATION.

PERFORMANCE FEATURES

This product is a forced type gas water heater. When powered on the waste gas will be forced to exhaust outside under the help of the draught fan.

Rain proof **INDOOR** gas water heater
Its rain proof design helps to stop the rain from dropping into the water heater. The water heater inhales air from outside to burn and exhaust the gas waste to outside, the user can operate the water heater through a remote control.

Temperature control system controls and coordinates the water, electricity, and gas to make sure the outlet water temperature is consistent.

Low start up water pressure

Flame-out protection, if the water heater flames out suddenly, it will cut off the gas automatically to make sure a gas leak does not occur.

⚠ WARNING

The water heater has an automatic draining function. When the water inlet pressure of the water heater exceeds 145 psi - 174 psi, the water heater will automatically drain. Please do not place objects around the water heater to avoid damage caused by water immersion of the water heater. When the water heater automatically drains the water, it indicates that the water system pressure is too high. After the pressure is reduced or the water valve is closed, confirm that the pressure meets the requirement for using the water heater.

NOTES

- The appliance will operate at reduced performance below 49 psi water pressure
 - For information relating to burner test point pressures and injector sizes refer to the name plate located on the right hand side of the case for each model.
- For information relating to overall dimensions and connection point refer to diagrams.
- Installing in areas over 1 mile above sea level will reduce performance.

PRODUCT DIMENSIONS

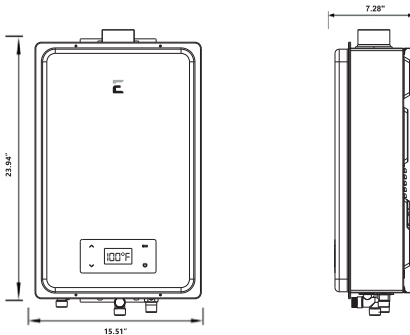

NOTICE: The National Fuel Gas Code (NFGC) mandates a manual gas shut-off valve: See (NFGC) for complete instructions. Local codes or plumbing authority requirements may vary from the instructions or diagrams provided and take precedent over these instructions.

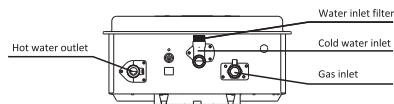
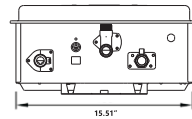

PLEASE NOTE: 6GB IS FOR INDOOR PERMANENT INSTALLATIONS ONLY. THIS MANUAL AND ALL ECCOTEMP CONTENT IS SUBJECT TO CHANGE WITHOUT NOTICE. PLEASE VISIT WWW.ECCOTEMP.COM/SUPPORT FOR MORE INFORMATION.

TECHNICAL DATA AND DIMENSIONS

| MODEL:6GB | ING | ILP |
|---|--------------------------------|-----------------------------|
| GAS INPUT | MIN:18,000 MAX:145,000 | MIN:18,000 MAX:145,000 |
| AVAILBALE CERTIFICATE | CSA,DOE | |
| FLOW RATE(45°F) TEMP RISE | 5.75 GPM | |
| PRODUCT DIMENSIONS(INCHES) | 23.94 x 15.51 x 7.28 | |
| PACAKAGE DIMENSIONS(INCHES) | 31.1 x 18.7 x 10 | |
| NET WEIGHT(LBS) | 37.38 | |
| GROSS WEIGHT(LBS) | 39.46 | |
| INSTALL TYPE | indoor, wall hung | |
| VENTING TYPE | category III type B | |
| IGNITION | electric | |
| WATER PRESSURE(PSI) | 15 - 150 | |
| GAS INLET PRESSURE W.C (KPA) | min: 3.5(.87), max: 10.5(2.61) | min: 8(1.99), max: 13(3.23) |
| ACTIVATION FLOW RATE(GPM) | .53 | |
| CONNECTION SIZES | 3/4" NPT | |
| RATED POWER SUPPLY(WATTS / AMPS) | 38 / .32 | |

WATER HEATER INSTALLATION

• Mark the wall with a dark mark, then drill three holes with a diameter of 8mm and a depth of 2 3/4 inch, then insert three 1/4 x 2 inch expansion screws into the hole and tighten the screws with a wrench.

• Hang up the water heater, screw on the 1/4 inch nut and fix the heater to the wall.

• Incorrect installation of the heater will affect the normal use of the water heater

PLUMBING NOTES

• When connecting the hot water supply to the fixtures of the property a minimum of 6.5 FT of pipe work must be used between the outlet of the water heater and first outlet. (Shown below)

• The hot water line should be insulated with armaflex or similar pipe insulation.

• When the installation is completed the temperature is to be tested at the outlet to confirm the water temperature does not exceed the required 122°F (50°C) setting.

• Water pipe size is nominal 1/2 inch from hot water outlet to the first outlet.

• Gas pipe size in nominal 3/4 inch.

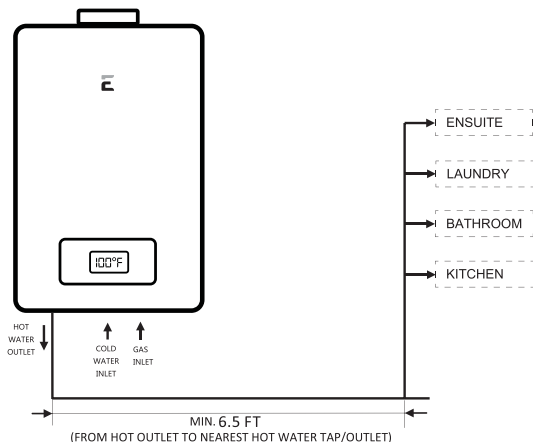

PLEASE NOTE: 6GB IS FOR INDOOR PERMANENT INSTALLATIONS ONLY. THIS MANUAL AND ALL ECCOTEMP CONTENT IS SUBJECT TO CHANGE WITHOUT NOTICE. PLEASE VISIT WWW.ECCOTEMP.COM/SUPPORT FOR MORE INFORMATION.

CONNECTING THE WATER

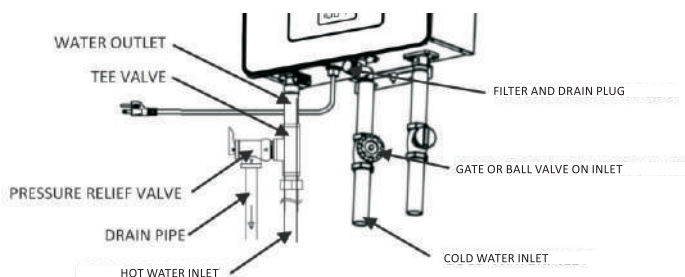

- All pipes, pipe fittings, valves and other components, including soldering materials, must be suitable for potable water systems.
- A manual shut off valve must be installed on the cold water inlet to the water heater between the main water supply line and the water heater.
- Only a gate valve or a ball valve is to be used on the cold water supply.
- Check the cold water pressure. If above 145 psi an approved limiting valve must be fitted.
- Before installing the water heater, flush the water line to remove all debris, and after installation complete, purge the air from the line. Failure to do so may cause damage to the heater. To prevent water heater water system damage caused by excessive pressure. At the water outlet of the water heater, it is necessary to install an appropriate pressure relief valve to protect the water system and user safety. The pressure relief valve complies with ANSI Z21.22/CSA 4.4
- In the hot water system, the temperature rises continuously, and the volume of water expands.
- If the system is equipped with an expansion tank or a flexible connection bellows can absorb a part of the expansion amount, the expansion tank or the soft connection bellows cannot absorb the pressure relief valve needed to protect the pressure relief valve to protect The entire system prevents breakage of pipes and other components, so the relief valve pressure setting is generally selected to be slightly less than the maximum pressure (Pmax) that the entire system can withstand.
- In addition, the pressure cannot be the same as the normal operating pressure, too close to the normal operation of the pressure relief valve will frequently pressure relief, lower temperature and pressure relief valve service life.
- In order to prevent the damage of the temperature probe or control system and cause the continuous heating of hot water to reach 212° F(100°C) vaporization, it is necessary to install a temperature and pressure safety valve, and the temperature and pressure valve temperature reaches 210° F(99°C) to relieve the pressure, thereby protecting the entire system. So the safety valve temperature is generally set to 210° F(99°C).
- There is a wire mesh filter to discourage debris from entering your heater. Clean filter after initial installation to ensure no debris from the pipe work has clogged it.

PLEASE NOTE: 6GB IS FOR INDOOR PERMANENT INSTALLATIONS ONLY. THIS MANUAL AND ALL ECCOTEMP CONTENT IS SUBJECT TO CHANGE WITHOUT NOTICE. PLEASE VISIT WWW.ECCOTEMP.COM/SUPPORT FOR MORE INFORMATION.

CONNECTING THE GAS

SIZING AND CONNECTION SUITABILITY

- Check the gas type label to make sure that the unit was built for the type of gas you will be using, and that the gas inlet pressure is within the appropriate range.
- Gas pressure below the specified range for the water heater and/or insufficient gas volume will adversely affect performance
- Inlet gas pressure must not exceed the maximum values, gas pressure above the specified range will cause dangerous operating conditions and damage the unit
- Until testing of the main gas line supply pressure is completed, ensure the gas line to the water heater is disconnected to avoid any damage to the water heater
- Always use approved connectors to connect the unit to the gas line. Always purge the gas line of any debris before connecting to the water heater.
- Install a manual gas shut-off valve between the water heater and the gas supply line.
- The regulator is preset to factory standards. It is computer controlled and is not to be adjusted by any person other than a licensed professional.
- When the gas connections are completed, perform a gas leak test either by applying soapy water to all gas fittings and observing for bubbles or by using a gas leak detection device.

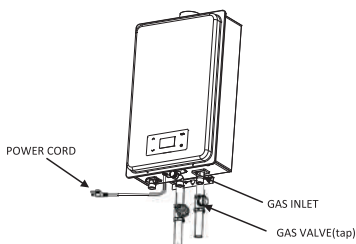

PRESSURE AND GAS LEAK TESTING

- 1) Shut off the manual gas valve on the supply gas line.
- 2) Open a tap/outlet. The unit should turn on and the air in the gas pipeline should be purged
- 3) Leave the tap/outlet running until the unit shuts down due to lack of gas supply. Then turn off the tap/outlet
- 4) Remove the screw on the pressure port located on the gas inlet of the water heater shown in the diagram to the right.
- 5) Connect the manometer to the pressure port.
- 6) Re-open the manual gas valve. Check to see that there are no gas leaks.
- 7) Open some of the fixtures that use a high flow rate to turn on the water heater.
- 8) Check the inlet gas pressure in the position shown in the circle above. When the heater is at maximum capacity, the gas pressure point must be within the appropriate range.

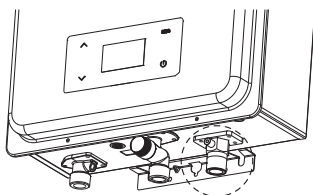

PLEASE NOTE: 6GB IS FOR INDOOR PERMANENT INSTALLATIONS ONLY. THIS MANUAL AND ALL ECCOTEMP CONTENT IS SUBJECT TO CHANGE WITHOUT NOTICE. PLEASE VISIT WWW.ECCOTEMP.COM/SUPPORT FOR MORE INFORMATION.

PRESSURE RELIEF VALVE

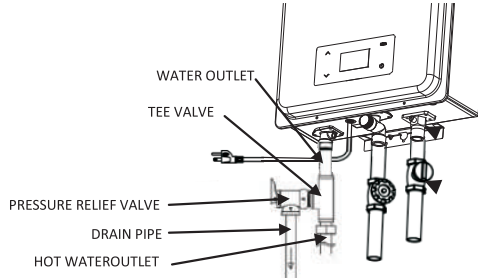

- Please use sealant tape to seal the thread of pressure relief valve, then install it into Tee valve G3/4 outlet (As shown above).
- Please use sealant tape to seal the thread of water outlet, then install pressure relief valve, tee valve and water outlet together. Please select a suitable position to install (As shown above).
- Please note that the outlet of pressure relief valve cannot face upward, otherwise it will always leave some water inside.
- Anti-fouling and anti-scaling, dirt will directly affect the normal function of the safety valve function. The drain pipe must match the drain port to ensure that the valve does not interfere with the normal operation of the valve.
- The pressure relief valve outlet can be installed horizontally or vertically, but it cannot make pressure outlet facing upwards, otherwise it cannot work normally. It is forbidden to block its outlet. The dirt will directly affect the normal function of the safety valve function. It requires hot water system maintenance of anti-fouling and anti-scaling cleaning.
- The user must check the relief valve at least once a year. When checking, turn off the water heater's power supply and gas. Turn on the water inlet switch to create pressure in the water system. Then gently open relief valve handle until there is water out and then gently close, if there is no water out, indicating that the valve is invalid, this time should immediately turn off the water heater water switch and ask the service personnel to deal with.
- Before operating the handle, check the discharge line connecting the valve to ensure that the water drained from the valve can be drained to a suitable place.

WIRING DIAGRAM

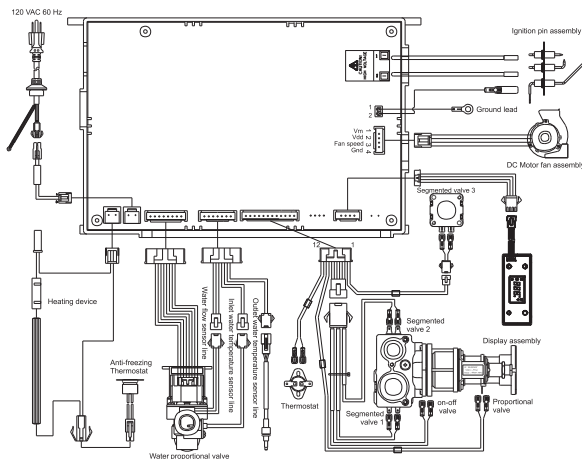

CONNECTING THE ELECTRIC

- The water heater must be electrically grounded. Do not attach the ground wire to either the gas or water piping.
- The water heater requires an AC 120V 60Hz.
- The weather-proof power point should be no more than 3FT from the base of the water heater for easy access.
- Install a power switch so that the electrical power can be switched off if necessary.
- If the cord supplied with this appliance must be replaced, it must be replaced with the correct appliance wiring material supplied by the Manufacturer.
- When servicing or replacing parts within the water heater, label all wires prior to disconnection to facilitate an easy and error free reconnection. Verify proper operation after servicing.

 **Warning**

Turn off the electric power to the water heater and manual gas valve located on the outside of the unit before beginning gas connection

Confirm the position of the gas inlet. Do not connect water line to gas inlet.

 **Warning**

Conversion of this unit from natural gas to propane (LPG) or propane (LPG) to natural gas cannot be done in the field. Contact your supplier to get the correct unit for your gas type.

PLEASE NOTE: 6GB IS FOR INDOOR PERMANENT INSTALLATIONS ONLY. THIS MANUAL AND ALL ECCOTEMP CONTENT IS SUBJECT TO CHANGE WITHOUT NOTICE. PLEASE VISIT WWW.ECCOTEMP.COM/SUPPORT FOR MORE INFORMATION.







CHECK THE WATER HEATER

After the installation of the water heater is completed, it is necessary to check that the water heater has no air leakage and water leakage, and the ignition operation is normal, and there is no fault alarm.

INITIAL OPERATION

FOR YOUR SAFETY, READ BEFORE OPERATING:

- Check the **GAS** and **WATER CONNECTIONS** for leaks before startup for the first time.
- Open the main gas supply valve to the unit using only your hand to avoid any spark. Never use tools. If the knob will not turn by hand, do not try to force it. Forced repair may result in a fire or explosion due to gas leaks.
- Check the **GAS PRESSURE**.
- Do not try to light the burner manually. It is equipped with an electronic ignition device which automatically lights the burner.
- Check for **PROPER VENTING** and **COMBUSTIBLE AIR** to the heater. Purge the **GAS** and **WATER LINES** to remove any air pockets.
- Do not use this water heater if any part has been submersed under water.

| | | |
|--|---|--|
| <p>1. Once the above checks have been completed, please clean filter of any debris. Refer to p. 24 for instructions.</p>  | <p>2. Fully open the manual water control valve on the water supply line</p>  | <p>3. Open a hot water tap to verify that water is flowing to that tap.</p>  |
| <p>4. Fully open the manual gas control valve installed.</p>  | <p>5. Turn on the 110 volt 60 Hz power supply to the water heater.</p>  | <p>6. Now you are ready to enjoy hours of endless hot water.</p>  |

PLEASE NOTE: 6GB IS FOR INDOOR PERMANENT INSTALLATIONS ONLY. THIS MANUAL AND ALL ECCOTEMP CONTENT IS SUBJECT TO CHANGE WITHOUT NOTICE. PLEASE VISIT WWW.ECCOTEMP.COM/SUPPORT FOR MORE INFORMATION.

NORMAL OPERATION

- 1) Turn on the power switch.
- 2) After confirming power is on, press the remote control power button "Ⓞ"
- 3) Open the inlet water valve and gas valves.
- 4) Open the water valve (hot water tap), the water heater will ignite and work, and hot water will flow out.
- 5) During the operation of the water heater, if the power supply suddenly stops, the water heater will stop working and close the gas valve. When the power is reset, the water heater with the remote control can be started by the remote control, and the water heater without the remote control can be started after re opening the water.
- 6) Power failure before operation, the water heater cannot start to provide hot water service.

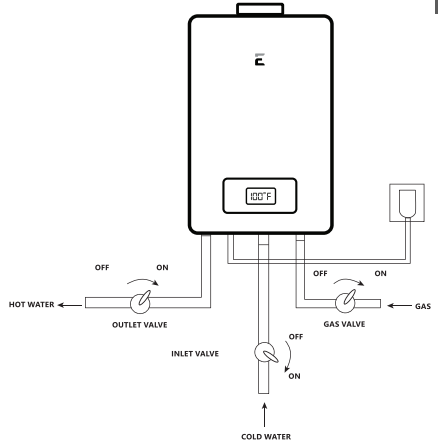

FREEZE PREVENTION

- Only the pipes and heat exchanger inside the water heater will be protected.
- Any hot or cold water pipes located outside of the unit will not be protected.
- Proper protection and insulation of these pipes will be required to ensure these are protected from freezing.

- 1) Turn Water Off
- 2) Turn Gas Off
- 3) Turn Off The Power Supply
- 4) Drain Water

⚠ WARNING

If freezing conditions are expected, turn off water and gas and drain all water from the appliance.

If power and the automatic frost protection are connected freezing will be prevented.

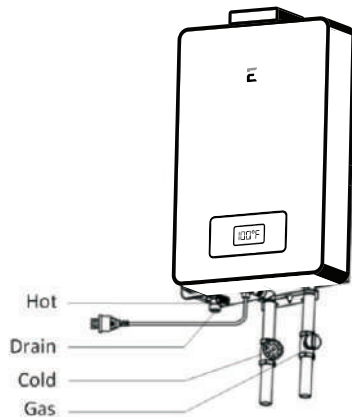

MAINTENANCE AND SERVICE

The water heater should be checked at least once a year or as necessary by a licensed technician.

If repairs are needed, any repairs should be done by a licensed technician. The water heater's lifetime may be extended by regular maintenance.

Clean the cold-water inlet filter. **(Refer to diagram below).**

Be sure that all openings for combustion air are not blocked. If blocked, remove obstruction. Check that the opening for exhaust is not blocked. If blocked, shut off the water heater's combustion. And then after a while, remove obstruction.

DO NOT touch while unit operating, otherwise you might get burnt due to high temperature. Check the gas pressure.

Keep the area around the water heater clear. Remove any combustible materials, gasoline or any flammable vapors and liquids.

UNIT DRAINING AND FILTER CLEANING

Close the manual gas shut off valve.

Turn off the power supply to the water heater. Close the manual water shut off valve.

Open all hot water taps in the house (Bathroom, kitchen, laundry, etc.). When the residual water flow has ceased, close all hot water taps.

Have a bucket or container to catch the water from the unit's drain plugs. Unscrew the drain plugs to drain all the water out of the unit.

Wait a few minutes to ensure all water has completely drained from unit.

Clean the filter: Check the water filter located within the cold inlet. With a tiny brush, clean the water filter of any debris which may have accumulated and reinsert the filter back into the cold water inlet. Securely screw the drain plugs back into place. Hand- tighten only.

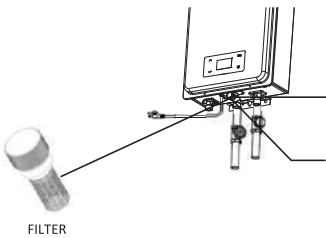

Remove by turning counter clockwise and then clean and replace

1. Turn off the water inlet supply valve.
2. Open a hot water tap to release the line pressure

PLEASE NOTE: 6GB IS FOR INDOOR PERMANENT INSTALLATIONS ONLY. THIS MANUAL AND ALL ECCOTEMP CONTENT IS SUBJECT TO CHANGE WITHOUT NOTICE. PLEASE VISIT WWW.ECCOTEMP.COM/SUPPORT FOR MORE INFORMATION.

TROUBLESHOOTING

| Temperature And Amount Of Hot Water | |
|--|--|
| Problem | Possible Solutions |
| The water is not hot enough | <ol style="list-style-type: none"> 1. Check cross plumbing between cold and hot water lines 2. Is the gas supply valve fully open? 3. Is the gas line sized properly? 4. Is the gas supply pressure enough? 5. Is the set temperature set too low? |
| The water is too hot | Is the set temperature set too high? |
| The hot water is not available when a fixture is opened. | <ol style="list-style-type: none"> 1. Make sure the unit has 120v 60hz power supply. 2. If you are using the remote controller, is the power button turned on? 3. Is the gas supply valve fully open? 4. Is the water supply valve fully open? 5. Is the filter on cold water inlet clean? 6. Is there enough lpg in the bottle? (For propane) |
| The hot water gets cold and stays cold. | <ol style="list-style-type: none"> 1. Is the flow rate enough to keep the water heater running? 2. Is the gas supply valve fully open? 3. Is the filter on cold water inlet clean? 4. Are the fixtures clean of debris and obstructions? |
| Fluctuation in hot water temperature. | <ol style="list-style-type: none"> 1. Is the filter on cold water inlet clean? 2. Is the gas line sized properly? 3. Is the supply gas pressure enough? 4. Check for cross connection between cold water lines and hot water lines |
| It takes a long time to get hot water at the fixtures | The time it takes to deliver hot water from the water heater to your fixtures depends on the length of piping between the two. The longer the distance or the larger the pipes, the longer it will take to get hot water. |
| The fan motor is still spinning after operation has stopped. | This normal. After operation has stopped, the fan motor keep running 15 - 75 seconds in order to re-ignite quickly, as well as push all exhaust gas out of the flue. |
| Remote Controller | |
| Problem | Possible Solutions |
| Remote controller does not display anything when the power button is turned on. | Press the on/off button If the light does not light up? <ol style="list-style-type: none"> 1. Make sure the unit has power. 2. Make sure the connection to the unit is correct. |
| An error code is displayed | Please see pg. 23 |
| Remote controller can not change the set temperature. | Is power light flashing? If it is not, locate priority controller and turn off, or wait for 15 mins on inactivity. |

PLEASE NOTE: 6GB IS FOR INDOOR PERMANENT INSTALLATIONS ONLY. THIS MANUAL AND ALL ECCOTEMP CONTENT IS SUBJECT TO CHANGE WITHOUT NOTICE. PLEASE VISIT WWW.ECCOTEMP.COM/SUPPORT FOR MORE INFORMATION.

PCB ERROR CODES

Troubleshooting :

When the water heater fails, the display will display the fault code, while the buzzer will issue continuously "Beep" alarm sound, please follow the table to deal with accordingly

| Error Code | Fault description and handling method |
|------------|--|
| E0 | Water temperature probe fault |
| E1 | Flame falt, please check whether the gas supply is normal or not, confirm the gas is correctly connected and then use |
| E2 | False fire fault |
| E3 | Thermostat protection |
| E4 | Water temperature probe fault |
| E5 | Fan fault, before the ignition, fan speed is detected for 8s less than 1000 r/min or when burning fan speed for 6s less than 600 r/min continuously. |
| E6 | Over-heating protection. Please check wether the water pressure is too low, confirm the water pressure is over starting pressure and then use |
| E7 | Solenoid valve fault |
| E8 | Flue jam fault |
| EN | The set shutdown time has been reached |

If any codes appear in the chart above and the water heater is functioning normally, restart the water heater. After restarting and it is not operating normally, please notify the after-sales service staff maintenance.

PLEASE NOTE: 6GB IS FOR INDOOR PERMANENT INSTALLATIONS ONLY. THIS MANUAL AND ALL ECCOTEMP CONTENT IS SUBJECT TO CHANGE WITHOUT NOTICE. PLEASE VISIT WWW.ECCOTEMP.COM/SUPPORT FOR MORE INFORMATION.

THE FOLLOWING CONDITIONS ARE NOT A FAULT

| Phenomenon | Reason and Handling Method |
|---|--|
| Exhaust white Smoke | INDOOR temperature is too low. The exhausted smoke encountered the cold air and then is condensing into a white mist. |
| Flow rate of generated hot water is too small to achieve requested water temperature | Hot water flow is too low to ignite the water heater. The water heater will not turn on if the flow is too low and then the water will become cold. Raise the flow rate higher to activate the heater. |
| Can't supply high enough temperature in winter | The incoming water temperature is very low and the water adjustment knob is already turned to maximum. The set temperature may be more than the heating capacity allows. Please adjust the flow lower to allow the water to heat to higher temperatures. |
| Water is too hot during the summer | Incoming water temperature is too high and the incoming flow is too low. It may cause the hot water to be too hot. Please adjust the flow to be more to lower the temperature. |
| The water heater turns off after 40 minutes | In order to prevent hypoxia, some models have a 40 minute timer protection function. When you continuously use the water heater for 40 minutes, it will turn off. Please turn off the tap and restart. |
| Close the hot water valve, but the fan does not stop immediately | The fan has a delay in the shutdown function in order to completely clean the water heater exhaust to ensure the safety of users. |
| Open the hot water valve, but hot water does not flow immediately | There is a distance from the water heater to the outlet, so the cold water in the line must flow out before the hot water reaches your outlet. The farther the distance from the water heater, the more time it takes to receive hot water. |
| There is always some water from the drain valve | This is because the inlet water pressure is too high and the drain valve will work to release the high pressure. Try to reduce the inlet water pressure by turning down the gate valve or the ball valve until water leakage stops. |

PLEASE NOTE: 6GB IS FOR INDOOR PERMANENT INSTALLATIONS ONLY. THIS MANUAL AND ALL ECCOTEMP CONTENT IS SUBJECT TO CHANGE WITHOUT NOTICE. PLEASE VISIT WWW.ECCOTEMP.COM/SUPPORT FOR MORE INFORMATION.

⚠ WARNING

1. Service shall be carried out only by authorized personnel and the appliance shall not be modified;
2. The appliance must be installed, commissioned and serviced by an authorized person in accordance with the requirements;
3. Warning: For continued safety of this appliance it must be installed, operated and maintained in accordance with the manufacturer's instructions

PLEASE NOTE: 6GB IS FOR INDOOR PERMANENT INSTALLATIONS ONLY. THIS MANUAL AND ALL ECCOTEMP CONTENT IS SUBJECT TO CHANGE WITHOUT NOTICE. PLEASE VISIT WWW.ECCOTEMP.COM/SUPPORT FOR MORE INFORMATION.

WARRANTY

Eccotemp Systems, LLC Limited Warranty Information

Model (s): 6GB ING/ILP Whole Home Tankless Water Heater

I. LIMITED WARRANTY

Subject to the terms below, Eccotemp Systems, LLC ("Eccotemp") provides this limited warranty (the "Limited Warranty") to cover the following Products and Covered Components:

| PRODUCT NAME | COVERED COMPONENTS |
|--|--|
| 6GB ING/ILP Whole Home Tankless Water Heater | 6GB ING/ILP Whole Home Tankless Water Heater and accessories: CSA certified gas regulator and hose, mounting hardware. |

This Limited Warranty is being provided to the original purchaser and subsequent owners (the "Owner"), but only while the Product remains as the site of the original installation.

II. LIMITED WARRANTY PERIOD

The term of this Limited Warranty (the "Warranty Period") begins on the date of purchase and ends as set forth below:

5 YEAR WARRANTY

The covered components, except for the Heat Element, in the Product are warranted by Eccotemp for a period of five (5) years from the date of purchase when installed according to Eccotemp's Installation and Operating Instructions.

10 YEAR WARRANTY

The Heat Exchanger in the Product is warranted by Eccotemp for a period of ten (10) years from the date of purchase when installed according to Eccotemp's Installation and Operating Instructions.

30 DAY WARRANTY

All accessories that have been provided with the Product at no cost are warranted by Eccotemp for a period of thirty (30) days from the date of purchase when installed according to Eccotemp's Installation and Operating Instructions.

If, during the Warranty Period, a component in the Product fails because of a manufacturing defect, Eccotemp will repair, replace, or refund the Product to the Owner at Eccotemp's sole discretion and as determined to be appropriate by the Eccotemp Support Team. As set forth in Section IV, the Owner may be responsible for all shipping, freight, and handling charges, as well as all fees and costs associated with the warranty service, including, but not limited to, all labor and other costs involved in diagnostic calls or in removing, repairing, servicing, or replacing any component. Eccotemp's sole responsibility under this Limited Warranty is to repair, replace, or refund the cost of the Product at Eccotemp's sole discretion. In the event that an exact replacement component is no longer available, Eccotemp will, at its option, provide a substitute component that Eccotemp deems suitable for the Product. If the Owner reports a subsequent issue with any covered component in the Product, the Owner may be responsible for retaining the failed component(s) for 90 days after a warranty claim is filed and must surrender the component(s) at the request of Eccotemp.

Both Eccotemp and the Owner of the Product are bound by this Limited Warranty.

IV. MAKING A WARRANTY CLAIM

To make a warranty claim through this Limited Warranty, the Owner must contact Eccotemp's Customer Service team at support@eccotemp.com, schedule a call or live chat on the Eccotemp support page at <http://support.eccotemp.com>. It is within Eccotemp's sole discretion when a repair, replacement, or refund will be issued. Any return for refund must be approved by Eccotemp's Customer Service team prior to shipping the Product back to Eccotemp. Please refer to Returning Your Product For Repair or Refund Policy provided with the Product.

Within the first 45 days of purchase, Eccotemp will cover all ground shipping costs for warranty related issues in the US and Canada, excluding Alaska, Hawaii and any location outside of the continental US and Canada. After the first 45 days of purchase, the Owner is responsible for all shipping to Eccotemp, regardless of reason or circumstance. Eccotemp will cover the warranty related shipping costs when returning the Product to the Owner after repair/inspection. The method for warranty related shipping will be ground equivalent with the provider within Eccotemp's sole discretion.

What information you will need for processing of your warranty claim:

- Proof of purchase
- Serial number
- Photos of the installation
- Photos of the damage point (if there is one)

All shipments of any type of product coming to Eccotemp for any reason must have a Return Goods Authorization ("RGA") number for any repairs to be made. Please contact Eccotemp to obtain an RGA number prior to shipping anything to Eccotemp. Failure to do so could result in loss of Product. Eccotemp will not be responsible for replacement due to loss or damage if these steps are not properly followed.

Any returns to Eccotemp must be sent in the original packaging. If your returned product does not have the original packaging and/or is missing any of the components that came with the product, there will be a nonnegotiable 15% restock fee.

PLEASE NOTE: 6GB IS FOR INDOOR PERMANENT INSTALLATIONS ONLY. THIS MANUAL AND ALL ECCOTEMP CONTENT IS SUBJECT TO CHANGE WITHOUT NOTICE. PLEASE VISIT WWW.ECCOTEMP.COM/SUPPORT FOR MORE INFORMATION.

WARRANTY CONTINUED

Eccotemp Systems ,LLC Limited Warranty Information

Model (s): 6GB ING/ILP Whole Home Tankless Water Heater

V. DISCLAIMER OF WARRANTIES AND RESPONSIBILITY FOR DAMAGES

EXCEPT AS PROVIDED IN THIS LIMITED WARRANTY, ECCOTEMP MAKES NO WARRANTY, EXPRESS OR IMPLIED, TO ANY ONE AS TO FITNESS FOR ANY PURPOSE, MERCHANTABILITY, DESIGN, CONDITION, CAPACITY, PERFORMANCE, OR ANY OTHER ASPECT OF THE PRODUCT OR ITS MATERIAL OR WORKMANSHIP. ALL IMPLIED WARRANTIES WHICH MAY EXIST, NOTWITHSTANDING THIS DISCLAIMER, ARE LIMITED TO THE DURATION OF THIS LIMITED WARRANTY. THIS LIMITED WARRANTY IS MADE IN LIEU OF ALL OTHER GUARANTEES, WARRANTIES, REPRESENTATIONS, CONDITIONS, OBLIGATIONS, OR LIABILITIES, EXPRESS OR IMPLIED.

ECCOTEMP SHALL NOT BE LIABLE, EITHER IN CONTRACT OR TORT, FOR ANY DIRECT, INDIRECT, INCIDENTAL OR CONSEQUENTIAL DAMAGES, OR ANY LOSS, DAMAGE, OR INJURY TO PERSONS, INCLUDING DEATH, PROPERTY, OR THINGS, OR FOR DAMAGES OF ANY KIND OR NATURE INCLUDING BUSINESS INTERRUPTION, INCONVENIENCE OR LOSS OF ANTICIPATED PROFITS OR SAVINGS OCCASIONED BY OR ARISING OUT OF THE USE, MISUSE, NONUSE, REPAIR, REPLACEMENT OR DELAY IN DELIVERY OF THE PRODUCT. ECCOTEMP SHALL NOT BE LIABLE FOR THE COST OF ANY WORK DONE BY PURCHASER OR OTHERS TO THE PRODUCT.

This Limited Warranty gives specific legal rights. Some jurisdictions do not allow the exclusion or limitation of implied warranties or incidental or consequential damages. In such jurisdictions, the limitations or exclusions do not apply to the Owner. The Owner may also have other rights that may vary by jurisdiction.

VI. EXCLUSIONS

The following exclusions apply to this Limited Warranty:

1. A repair, replacement, or refund will not be provided under this Limited Warranty unless the Product containing the defective component is properly installed and maintained according to Eccotemp's Installation Manual and Use & Care Manual and in compliance with all applicable federal, state/province, and local laws, regulations, codes, policies, and licensing requirements. Any abuse, misuse, alteration, neglect, or misapplication of the Product will render this Limited Warranty null and void.
2. A repair, replacement, or refund will not be provided if the Product is damaged by services performed by third party service providers other than Eccotemp Systems.
3. Eccotemp systems is not responsible for any expenses arising from labor services, including but not limited to, installation or removal services due to a warranty claim.
4. A repair, replacement, or refund will not be provided if the Product is used in a hot water circulation loop, in series with a circulation system, where an on-demand recirculation system is incorporated, or in any other corrosive or otherwise destructive environment where the Product is not intended to be used as set forth in Eccotemp's Installation Manual and Use & Care Manual.
5. A repair, replacement, or refund will not be provided if the Product is damaged as a result of improper installation, including improper ventilation materials, sizing, length, elevation, condensation drainage, or inadequate airflow.
6. A repair, replacement, or refund will not be provided if the Product is damaged as a result of improper use, including freezing within the unit or surrounding piping, incorrect sizing for the application, scale build up, or incorrect gas and/or water pressure.
7. This Product shall not be used as a pool or spa heater. Use of the Product as a pool or spa heater shall be considered misuse and will render this Limited Warranty null and void.
8. A repair, replacement, or refund will not be provided if the Product is damaged by the use of non-potable, untreated or poorly treated well water, or water with high PH levels or hardness levels in excess of 12 grains per gallon (200 mg/L).
9. A repair, replacement, or refund will not be provided under this Limited Warranty if the original serial number on the Product has been removed or altered in a way that causes the serial number to not be readily determined.
10. Eccotemp will not pay electricity or fuel costs, or increases in electricity or fuel costs, for any reason whatsoever, in cluding additional or unusual use of supplemental electrical heat.
11. Eccotemp will not be responsible for any default or delay in performance under this Limited Warranty caused by any factor or contingency outside of its control.

VII. MISCELLANEOUS

No agent, employee or representative of Eccotemp has any authority to bind Eccotemp to any representation or warranty concerning the Product not contained in this Limited Warranty. Eccotemp reserves the right and authority to change, modify or alter this warranty at any given time.

VIII. FOR CUSTOMERS WITH A HOME WARRANTY

Often your home warranty will assist in covering some of the fees related to your home appliances, such as your water heater. Be sure to check with your home warranty company for assistance prior to reaching out to Eccotemp.



315 Industrial Road, Summerville, SC 29483 | 1-866-356-1992

© Eccotemp 2022 All Rights Reserved | Printing Version 1.0