

Paramount

Item number:EF-WM326
Model number:BLT-999W-3-S

CURVED WALLMOUNT ELECTRIC FIREPLACE

INSTRUCTIONS FOR USE



Rated Voltage: 110-120V~
Rated Frequency: 60Hz
Rated Power: 1400W

READ & SAVE THESE INSTRUCTIONS

Carefully read and review before assembling, installing, operating or maintaining this product. Observe all safety instructions and information.

**FAILURE TO FOLLOW WARNINGS & OPERATIONAL
INSTRUCTIONS CONTAINED IN THIS MANUAL CAN RESULT
IN PROPERTY DAMAGE OR PERSONAL INJURY.**

****IMPORTANT NOTICE****

Please contact our toll free hotline:
1-800-561-5550
customercare@jrhome.com
For customer service & warranty issues



Read these instructions completely before beginning installation. Failure to follow them could cause a heater malfunction resulting in serious injury and/or property damage.

 **WARNING:** All electric heaters have hot and arcing or sparking parts inside. Do not use it in areas where gasoline, paint or flammable liquids are present.

 **WARNING:** This electric fireplace is tested and listed for use only with the optional accessories listed in these instructions. Use of optional accessories not specifically tested for this electric fireplace could void the heater warranty and/or result in a safety hazard.

This electric fireplace meets the construction and safety standards of H.U.D. for application in manufactured homes when installed according to these instructions.

TABLE OF CONTENTS

Important Safety Instructions.....	4
Listing Approvals	7
Product Dimensions	8
Locating Fireplace	9
Unpacking and Testing Fireplace	10
Grounding Instructions.....	10
Installation	11
Finishing Checklist	12
Operating Instructions	13
Maintenance	14
Troubleshooting	15
Warranty	17

IMPORTANT SAFETY INSTRUCTIONS

- 1/ Prior to plugging your heater into an electrical outlet, verify that the house circuit breakers for the outlet are on.
- 2/ The heater may emit a slight, harmless odor when first used. This odor is normal and it is caused by the initial heating of internal heater elements and will not occur again.
- 3/ If your heater does not emit heat, consult the operation section of this manual for further information.
- 4/ Use with a CSA or UL certified surge protector.

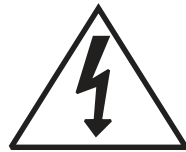

SA1965

CAUTION:
RISK OF ELECTRIC SHOCK
DO NOT OPEN
NO USER-SERVICEABLE PARTS INSIDE
HIGH TEMPERATURE



SA1965

KEEP ELECTRICAL CORDS, DRAPERY AND OTHER FURNISHINGS AT LEAST 3 FEET (0.9m) FROM THE FRONT AND SIDES OF THE HEATER.

CAUTION: High temperature, risk of fire. Keep electrical cords, drapery, furnishings, and other combustibles at least 3 feet (0.9m) from the front of the heater and away from the side and rear.

WARNING: Servicing should be done only while the heater is disconnected from the power supply circuit.

IMPORTANT SAFETY INSTRUCTIONS

When using this electric fireplace, basic precautions should always be followed to reduce the risk of fire, electric shock and injury to persons, including the following:

1/ Read all instructions before using this electric fireplace.

2/ This heater is hot when in use. To avoid burns, do not let bare skin touch hot surfaces. Keep combustible materials, such as furniture, pillows, bedding, papers, clothes and curtains at least 3 feet (0.9m) from front of heater and keep them away from sides and rear

3/ Extreme caution is necessary when any heater is used by or near children and whenever the heater is left operating and unattended.

4/ Always unplug electric fireplace when not in use.

5/ Do not operate this electric fireplace with a damaged cord or plug or after heater malfunctions, has been dropped or damaged in any way. Return heater to authorized service facility for examination, electrical or mechanical adjustment or repair.

6/ Do not use this electric fireplace outdoors.

7/ This electric fireplace is not intended for use in bathrooms, laundry areas and similar indoor locations. Never locate electric fireplace where it may fall into a bathtub or other water container.

8/ Do not run cord under carpeting. Do not cover cord with throw rugs, runners or the like. Arrange cord away from traffic area and where it will not be tripped over.

9/ To disconnect electric fireplace, turn controls to "OFF" before removing plug from outlet.

10/ Connect to properly grounded outlets only.

11/ Do not insert or allow foreign objects to enter any ventilation or exhaust opening as this may cause an electric shock or fire or damage the heater.

IMPORTANT SAFETY INSTRUCTIONS

12/ To prevent possible fire, do not block air intakes in any manner. Do not use on soft surfaces, like a bed, where openings may become blocked.

13/ The electric fireplace has hot and arcing or sparking parts inside. Do not use it in areas where gasoline, paint or flammable liquids are used or stored.

14/ Use this electric fireplace only as described in this manual. Any other use not recommended by the manufacturer may cause fire, electric shock or injury to persons.

15/ Always use properly grounded fused and polarized outlets.

16/ Always use ground fault protection where required by electrical codes.

17/ Always disconnect power before performing any cleaning, maintenance or relocation of heater.

18/ To prevent a possible fire, do not burn wood or other materials in this electric fireplace.

19/ To prevent electric shock or fire, always hire a certified electrician should new circuits or outlets be required.

20/ When transporting or storing this electric fireplace, keep in a dry place free from excessive vibration and store as to avoid damage.

21/ Always plug heaters directly into a wall outlet/receptacle. Never use with an extension cord or relocatable power tap (outlet/power strip)

22/ DANGER-HIGH Temperatures may be generated under certain abnormal conditions. Do not partially or fully cover or obstruct the front of this heater.

23) This appliance is not intended for use by persons (including children) with reduced physical, sensory or capabilities, or lack of experience and knowledge, unless they have been given supervision or instruction concerning use of the appliance by a person responsible for their safety. Children should be supervised to ensure that they do not play with the appliance.

24) CAUTION: In order to avoid a hazard due to inadvertent resetting of the thermal cut-out, this appliance must not be supplied through an external switching device, such as a timer, or connected to a circuit that is regularly switched on and off by the utility.

SAVE THESE INSTRUCTIONS!

LISTING APPROVALS

This heater has been tested in accordance with the CSA Standards for fixed and location-dedicated electric room heaters in the United States and Canada. If you need assistance during installation, please contact your local dealer.

Model Number:	BLT-999W-3-S / □□□□ M□3□6
Description:	Wall Mount Electric Fireplace
Voltage:	120V AC
Watts:	MAX1400 W
Amps:	15Amp Grounded Circuit
Length:	23 , 6"
Height:	17.8"
Depth:	5.5"

Note: This heater must be electrically wired and grounded in accordance with local codes or, in the absence of local codes, with National Electric Code ANSI/NFPA 70-latest edition or the Canadian Electric Code, CSA C22.1 as appropriate.

PRODUCT DIMENSIONS

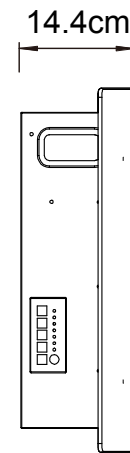
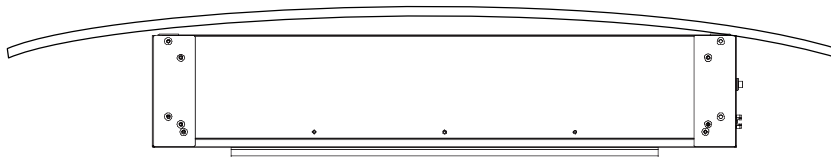
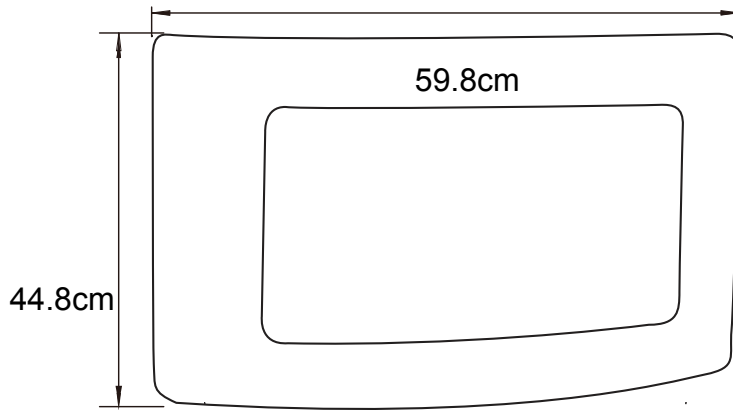
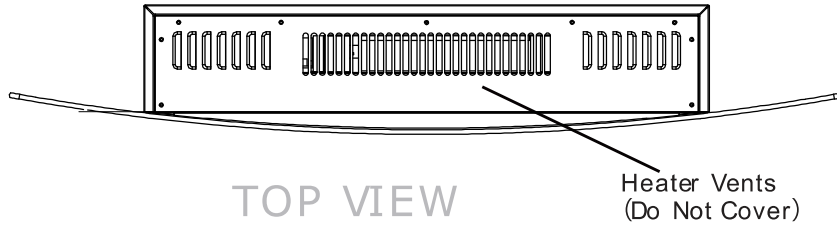

BOTTOM VIEW

SIDE VIEW

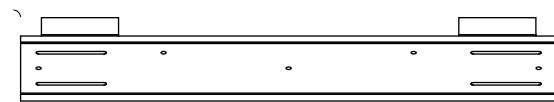
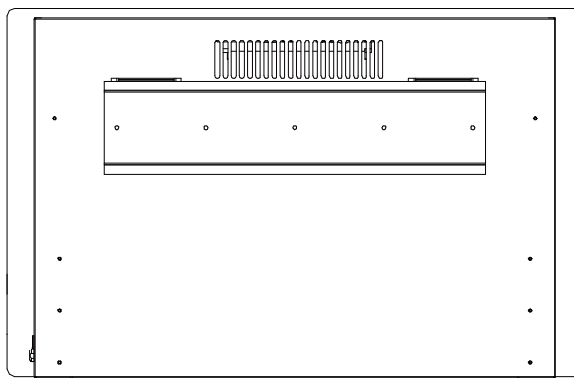

Mounting holes

BACK VIEW

Figure 1
Fireplace Dimensions

LOCATING FIREPLACE

 **WARNING:** Due to high temperatures, this electric fireplace should be located out of traffic. Keep combustible materials such as furniture, pillows, bedding, papers, clothes and curtains at least 3 feet (0.9m) from the front of the heater.

 **WARNING:** Never locate this electric fireplace where it may fall into a bathtub or other water container.

 **CAUTION:** Do not expose the electric fireplace to the elements (such as rain, etc.)

 **CAUTION:** Wear gloves and safety glasses for protection during installation and maintenance.

 **WARNING:** To prevent contact with sagging or loose insulation, the electric fireplace must not be installed against vapor barrier or exposed insulation. Localized overheating could occur and a fire could result.

UNPACKING AND TESTING FIREPLACE

Carefully remove the unit from the box. Prior to installing the unit, test to make sure the unit operates properly. To do this, plug the unit's power supply cord into a conveniently located 120-Volt grounded outlet.

GROUNDING INSTRUCTIONS

This insert is for use on 120 Volts.

The cord has a plug as shown in (A) of Figure 2 given below.

Always plug heaters directly into a wall outlet/receptacle. Never use with an extension cord or relocatable power tap (outlet/power strip)

To disconnect heater, turn controls to off, then remove the plug from outlet.

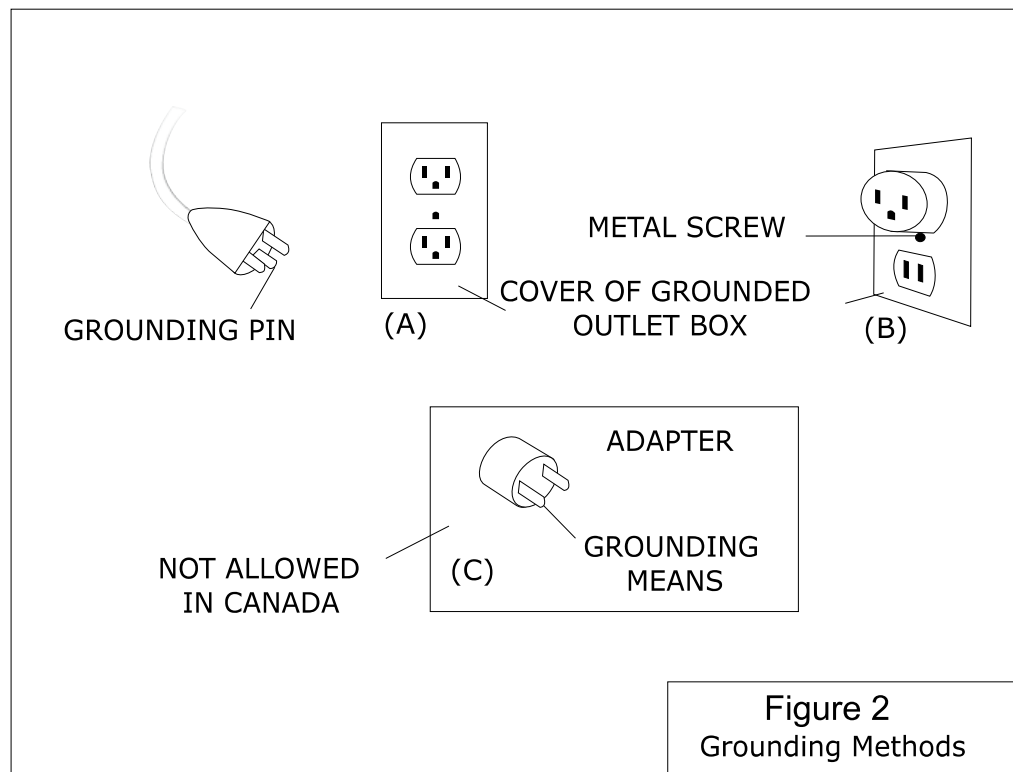

INSTALLATION

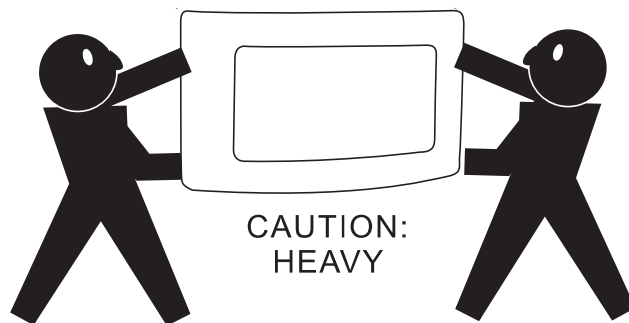
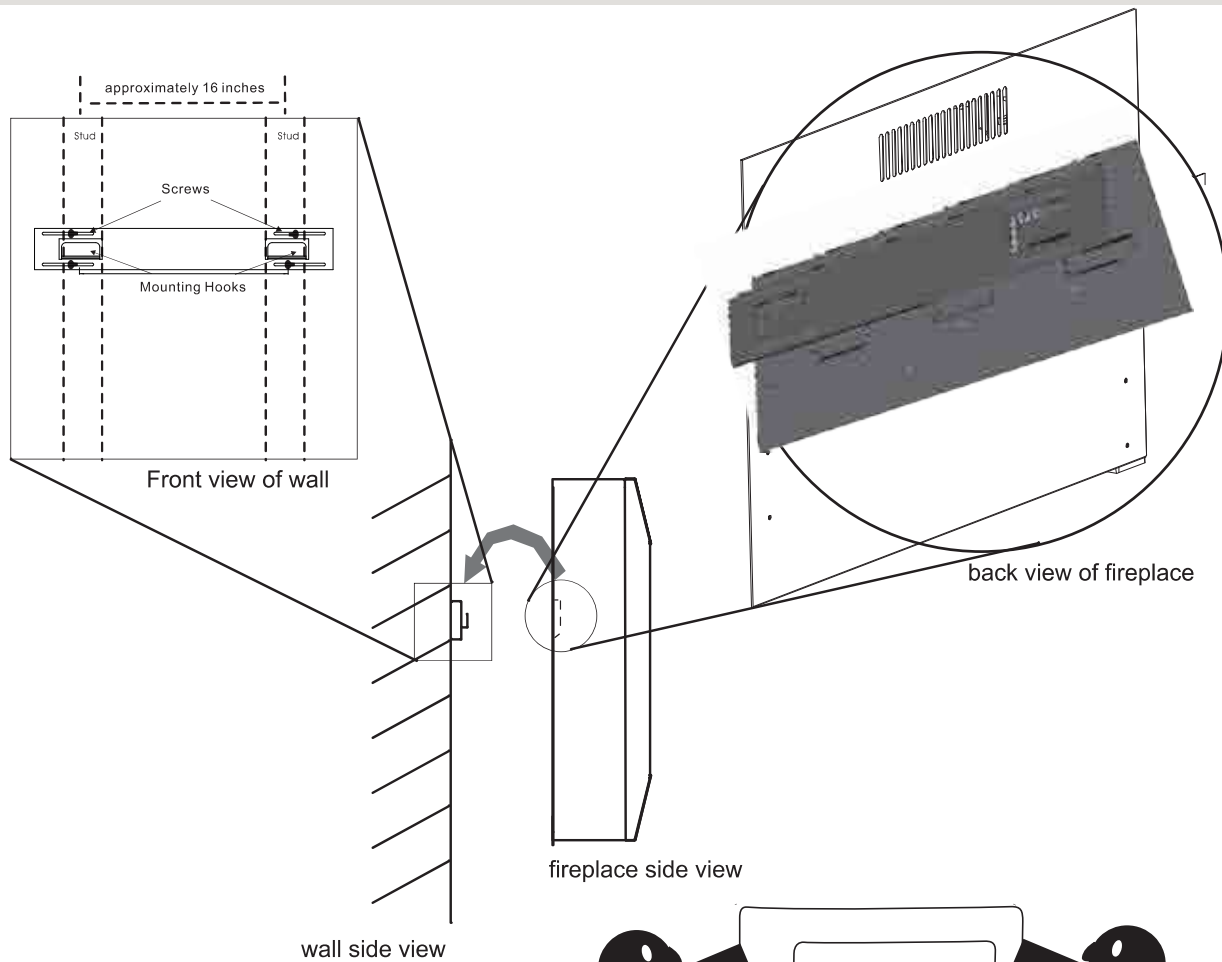

This fireplace must be mounted on a wall with a height above the floor between 0.5M and 2.5M.



WARNING: Heater vents (see Figure 1, page 4) on this electric fireplace cannot, in any way, be covered as it may create a fire hazard.



Due to the many different materials used on different walls, it is highly recommended that you consult your local hardware store to determine what type of mounting screws are needed before you install this fireplace onto the wall.

FINISHING CHECKLIST

- > Power supply service must be completed prior to finishing to avoid reconstruction.
- > Heater vents and air openings cannot be covered in any circumstances.

OPERATING INSTRUCTIONS

Once the unit has been properly connected to a grounded electrical outlet, it is ready to operate.

Note: Ensure the house circuit breakers for the power supply are turned on.



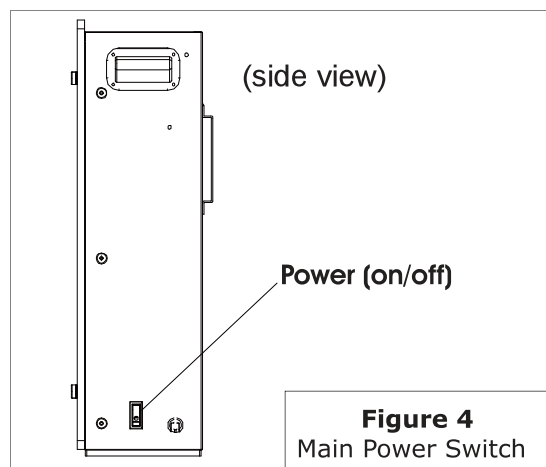

Main Power Switch:

The Main Power Switch is located on the right side of the unit. Figure 4 illustrates the location of the switch. The "I" indicates ON and "O" indicates OFF. Push the switch to "I" to turn on the unit and the flame effect. The red LED Indicator will be turned on.



OPERATING INSTRUCTIONS

Operation Of Control Panel & Remote Control

BUTTON	FUNCTION
on off	ON (I) . Enables all functions. OFF (O) . Turns off all functions on control panel and remote control.
	ON : Enables touch panel functions and remote control. Turns on flame effect. OFF : Disables touch panel functions and remote control. Turns off flame effect.
	TIMER button : Controls timer settings to turn off fireplace at selected time. Settings range from 1.0 hours to 9.0 hours.
	FLAME “-” : Makes flame effect dimmer. NOTE : Flame effect stays on until power button is turned off. Flame effect must be on for heater to turn on.
	FLAME “+” : Makes flame effect brighter. NOTE : Flame effect stays on until power button is turned off. Flame effect must be on for heater to turn on.
	HEATER button : Turns heater on and off. NOTE : The heater only works when the flame effect is on. If the flame effect is off, the heater will not turn on. NOTE : To prevent overheating, the heater blows cool air for 10 seconds before the heater turns on, and after it turns off.

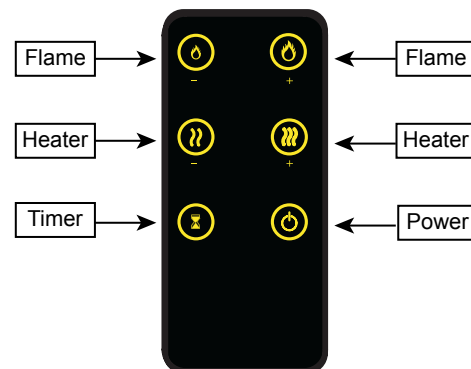
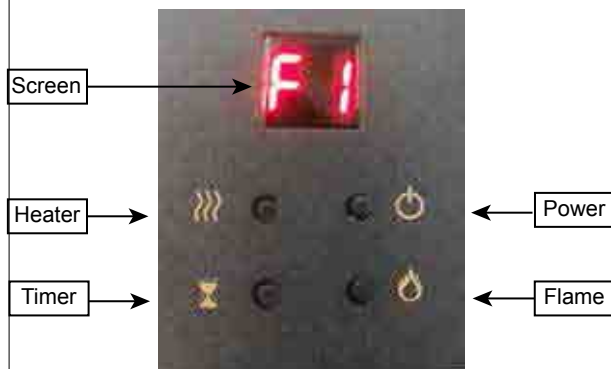

To reset the Heater

The appliance is fitted with a protection system. The heater includes a protection system that shuts off the heater if it overheats for any reason:

- Turn unit to off
- Unplug unit wait 5 minutes
- Plug in and turn on.
- Remote control functions

In order to protect the product from becoming too hot, there is an 8 second delay when turning on the heater, also there is an 8 second delay when turning off the heater fan.

MAINTENANCE

Maintenance

Warning: Before any maintenance and /or cleaning the exterior of the fireplace, disconnect the unit from the socket and leave to cool.

Remote Handset Battery Replacement: This remote control includes the battery, Make sure the batteries are installed correctly in the remote control.

Cleaning the fireplace

The area around the fireplace should be kept free of any materials such as lint or house dust. You can clean the outside of the appliance with a soft damp . Do not use furniture or metal polish.

Warning: An authorized service representative should perform any other servicing.



Preparation for Maintenance

WARNING: Always disconnect the power and allow the electric fireplace to cool completely before performing any cleaning, maintenance or relocation of this electric fireplace. Turn all controls to OFF and remove plug from outlet or turn off the house circuit breaker to electric fireplace receptacle.

TROUBLE SHOOTING



WARNING: Turn off the fireplace completely and let cool before servicing.

OBSERVED PROBLEM	POSSIBLE CAUSE	REMEDY
No warm air is coming out of the heater. Heat doesn't turn on when it is set to Low setting.	1. Room temperature is higher than the heater setting (if it is set to LO or MED)	1. Set heater to a higher temperature setting (MED or HI)
Fireplace turns off and will not turn on	1. Fireplace has overheated and safety device has caused the thermal switch to disconnect 2. House circuit breaker has tripped	1. Unplug the unit, allow heater to cool for 10 minutes, then plug it back in 2. Reset house circuit breaker
Fireplace will not come on when switch is flipped to ON	1. Fireplace is not plugged into an electrical outlet 2. Fireplace has overheated and safety device has caused the thermal switch to disconnect	1. Check plug and plug it in 2. Unplug the unit, allow heater to cool for 10 minutes, then plug it back in
Remote control does not work	1. Low batteries	1. Replace AA batteries in remote control

IMPORTANT

For questions, concerns or problems with our product please email our customer service department:
customercare@jrhome.com or call 1-800-561-5550.
DATED PROOF OF PURCHASE REQUIRED FOR WARRANTY SERVICE.

WARRANTY

This product is inspected, tested and carefully packaged to minimize the chance of damage during shipment. If a part (excluding light bulbs, glass and fuses*) within one year from the date of purchase proves to be defective in material or fabrication under normal use, the part will be repaired or replaced. The Company's obligation under the warranty is to replace or repair defective parts at our discretion. Any expenses or damage resulting from the installation, removal or transportation of the product will be the responsibility of the owner and are not covered by this warranty. The owner assumes all other risks arising from the use or misuse of the product. The warranty will be void if the product damage or failure is deemed by the Company to be caused by accident, alteration, misuse, abuse, incorrect installation or removal, or connection to an incorrect power source by the owner. The Company neither assumes, nor authorizes any person or entity to assume for it any obligation or liability associated with its products. Light bulbs and fuses are not covered under this warranty. If you have any questions regarding the warranty or service, please call our toll free number: 1-800-561-5550.

Customer Service
JR Home Products
Unit 306 - 19100 Airport Way, Pitt Meadows, BC V3Y 0E2
Toll Free: 1-800-561-5550
E-mail: **customercare@jrhome.com**

You **MUST** register your product to receive warranty service.
Registration can be completed online at www.jrhome.com or by mailing this form.

Warranty Registration Information Form / Formulaire d'enregistrement de la garantie

Name / Nom: _____
Street / Address: _____
City / Ville: _____
Province / Province: _____
Postal Code / Code postal: _____

Daytime Phone # / No téléphone jour: _____
Evening Phone # / No téléphone soir: _____

E-Mail Address / Courriel: _____

Product/Produit: _____
Place of Purchase / Lieu de l'achat: _____
Date of Purchase / Date de l'achat: _____
Model # / No de modèle: _____
Serial # / Numéro de série: _____

You **MUST** register your product to receive warranty service.

For warranty service, contact J&R Home Products at the address, phone numbers listed below within 30 days of purchase. Be sure to have your sales receipt and original date of purchase. All warranty service will be coordinated by J&R Home Products service center.

Vous **DEVEZ** enregistrer votre produit pour vous prévaloir de la garantie.

Afin de faire valoir la garantie, communiquez avec J&R Home Products à l'adresse et aux numéros indiqués ci-dessous dans les 30 jours suivant la date d'achat. Ayez en main votre reçu et la date d'achat. Toutes les demandes liées aux garanties seront traitées par le centre de service de J&R Home Products.

Please mail to / Veuillez poster le tout à : Parts & Service Department, J&R Home Products Ltd. Unit 306 - 19100 Airport Way, Pitt Meadows, BC V3Y 0E2