

FBB20-1 DUAL BLOWER KIT INSTALLATION INSTRUCTIONS

FOR USE ON DVLL(48,60)BP SERIES LINEAR FIREPLACES

INSTRUCTIONS MUST BE LEFT WITH THE OWNER FOR FUTURE REFERENCE AFTER INSTALLATION.

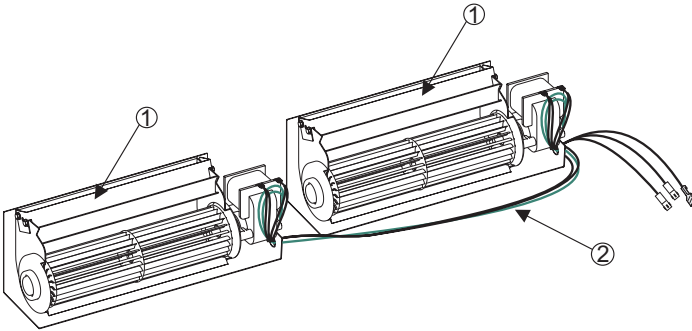

BLOWER ASSEMBLY PARTS LIST			
INDEX NO.	PART NO.	DESCRIPTION	QTY
1	35727	Blower Assembly - Single	2
2	R12390	Wire Harness	1

TOOLS NEEDED:

- 5/16in Nut driver or screw gun

⚠ CAUTION

Sharp edges. Use gloves when installing these blowers.

INSTALLATION - PRIOR TO SETTING FIREPLACE INTO FINAL POSITION

1. Unpack the FBB20 Blower assembly.
2. Using a 5/16in hex drive, remove the 11 screws holding rear blower access cover plate, then lay the access plate on the floor. **See Figure 1.**



Figure 1

3. Use a rag to wipe the inside bottom of the fireplace (where the blowers will be placed) to remove dirt or construction dust.
4. Place blowers on the floor behind the fireplace. Position the blowers with the two black connecting wires and green ground wire towards the left hand side when facing the back of the fireplace. **See Figure 2.**

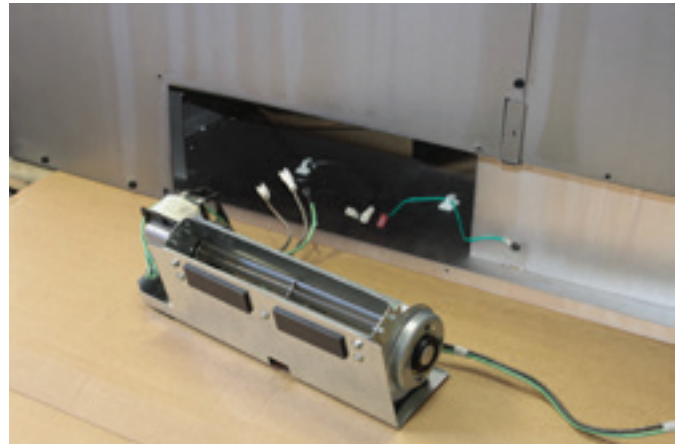

Figure 2

5. Locate the blower wire terminals inside the bottom of the fireplace and make the three connections as shown in **Figure 3.**

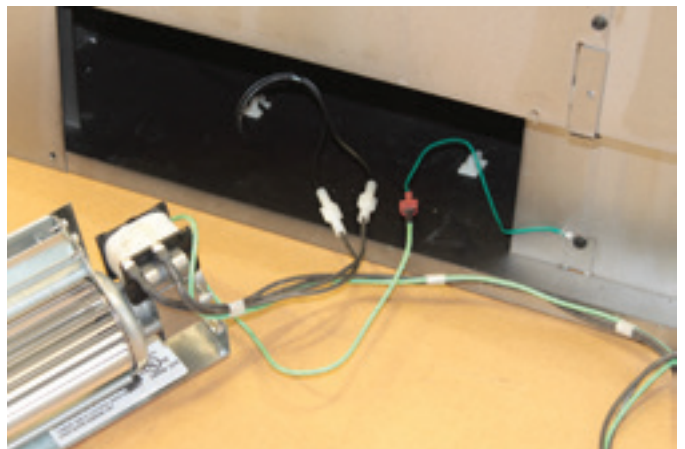

Figure 3

6. Begin installing the left blower assembly into the bottom of the fireplace. Once the blower is about half way in, secure wiring within the white plastic wire retention clips provided in the fireplace. **See Figure 4.**

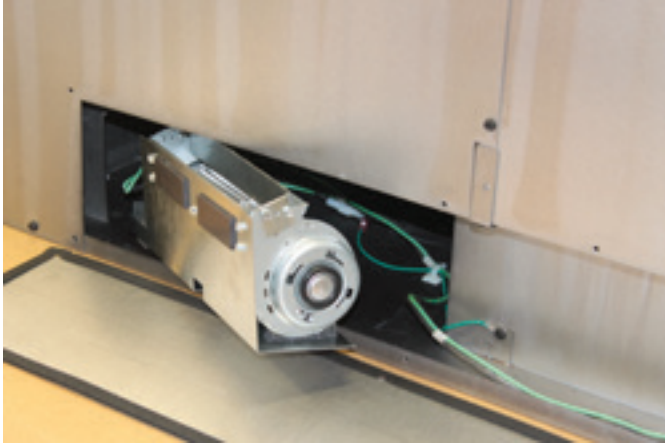

Figure 4

7. Finish installing the left blower so that the left edge of the blower base bracket is about even with the left edge of the access opening. Route the wiring away from the blower wheel. **See Figure 5.**

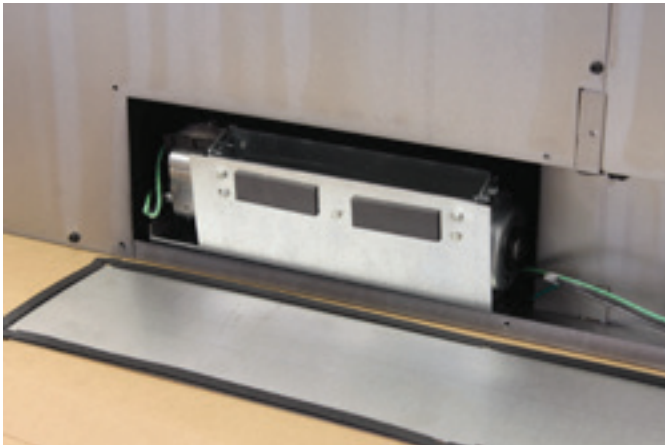

Figure 5

8. Next, install the right hand blower assembly towards the right side of the access opening. The right hand edge of the blower base bracket should be about even with the right edge of the access opening. Route wiring away from the blower wheel. **See Figure 6.**

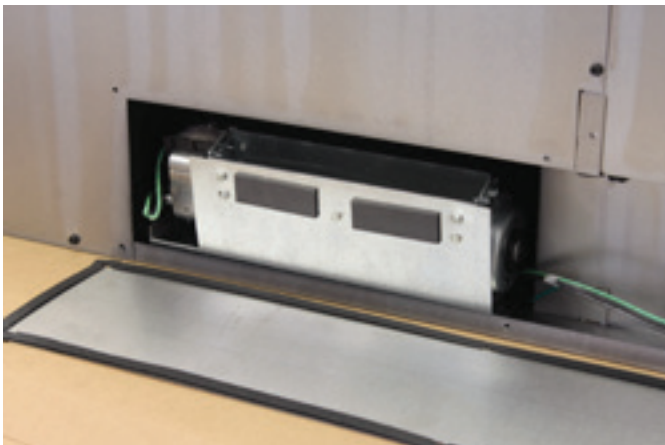

Figure 6

9. Snap the wire harness into the white plastic wire retention clip located at the center bottom of the fireplace. **See Figure 7.**



Figure 7

10. Make sure the blower base brackets are pulled rearward against the bottom flange of the fireplace. The magnets on the blower base bracket will keep the blowers in place. **See Figure 8.**

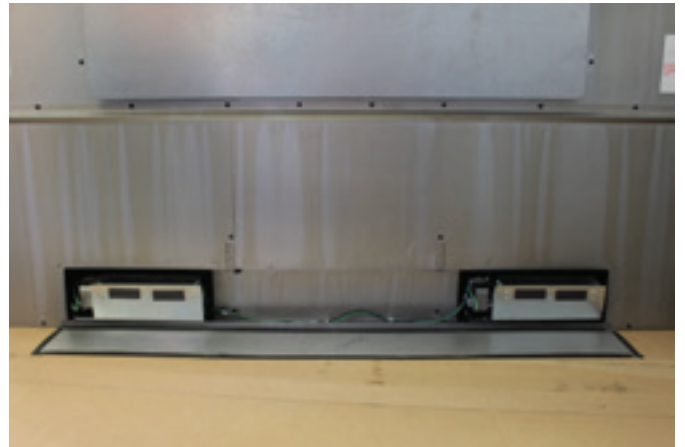

Figure 8

11. Re-attach the Blower Access Panel with the 11 screws removed in step 2. **See Figure 1.**
12. Blower installation is complete.

INSTALLATION – AFTER THE FIREPLACE HAS BEEN INSTALLED (WITH NO ACCESS TO THE BACK OF FIREPLACE)

NOTE: To install the FBB20 Dual Blowers after the fireplace has been installed or there is no rear accessibility for installation, follow these steps and illustrations for proper installation.

1. Unpack the FBB20 Blower assembly and verify that it has not been damaged during shipping.
2. Refer to the fireplace installation manual for removal of the Barrier Screen and Glass Door assemblies, and set them aside.
3. Be sure to turn off gas supply and electrical power to the fireplace while servicing and/or installing the blower assembly.
4. Remove all decorative glass media and other internal optional accessories from inside the firebox.
5. Remove the front Light Cover. Lift the cover up and out of the fireplace, then set aside.
6. If a liner is installed in the fireplace, it must be removed using instructions supplied with the liner kit.
7. Once the liner set has been removed and set aside, carefully lift the two accent glass panels up and out of the fireplace and set aside.
8. Next, grasp the burner cover assembly in front of the burner screen and lift upward to remove, and set aside. **See Figure 9.**

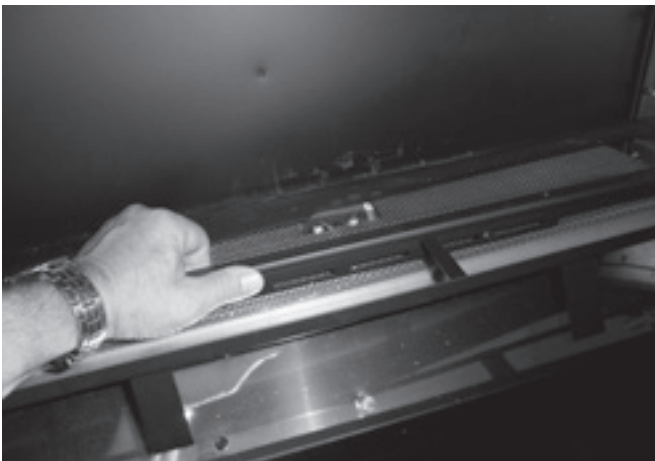

Figure 9

9. Lift the burner screen off of the burner and set aside. **See Figure 10.**

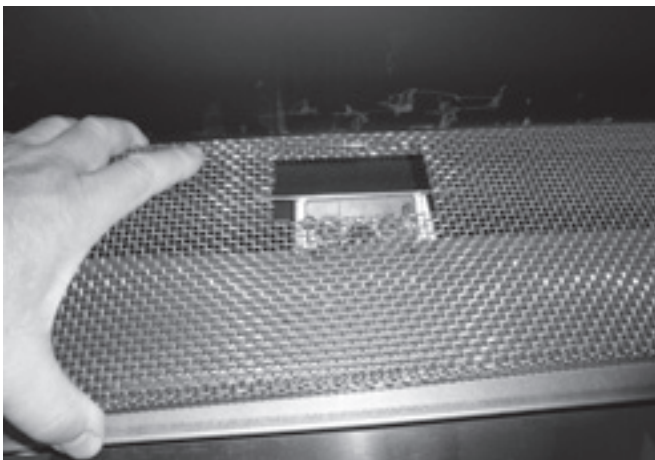

Figure 10

10. Using a 5/16" Hex drive socket, remove the two screws that retain the rear baffle, and remove the baffle. **See Figure 11.**

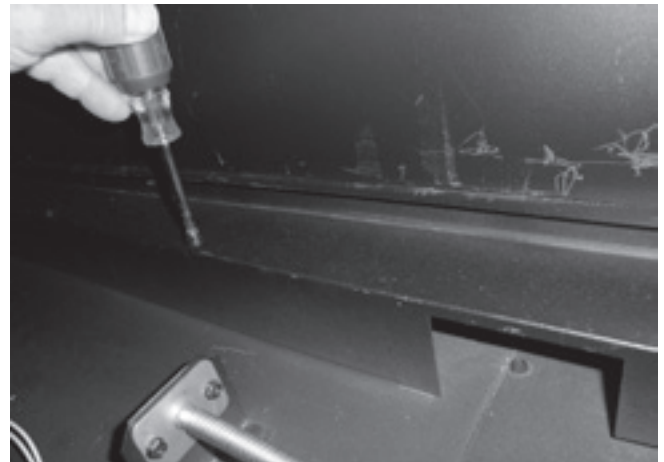

Figure 11

11. Remove the two screws that hold the pilot bracket to the back edge of the burner assembly, then gently move the pilot assembly (with the pilot bracket) back away from the burner. **See Figure 12.**



Figure 12

12. Remove one screw at each end bracket that secures the burner assembly to the firebox bottom. **See Figures 13 & 14.**



Figure 13

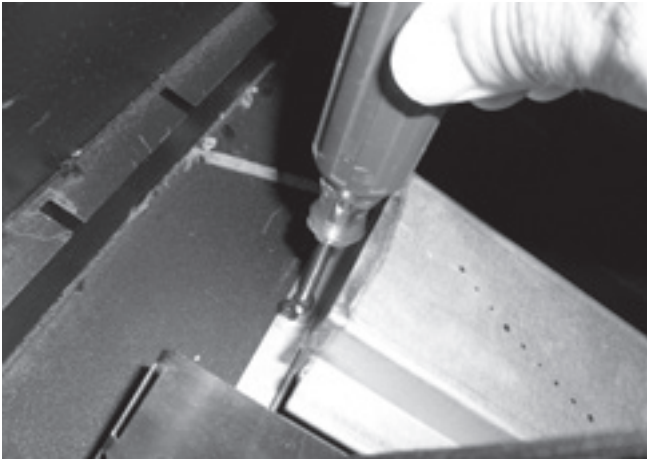

Figure 14

13. Grasp the burner assembly, then shift the burner assembly about $\frac{3}{4}$ inch to the left to release the air shutter off of the orifice holder. Once free, lift the burner assembly out of the fireplace and set aside. **See Figure 15.**

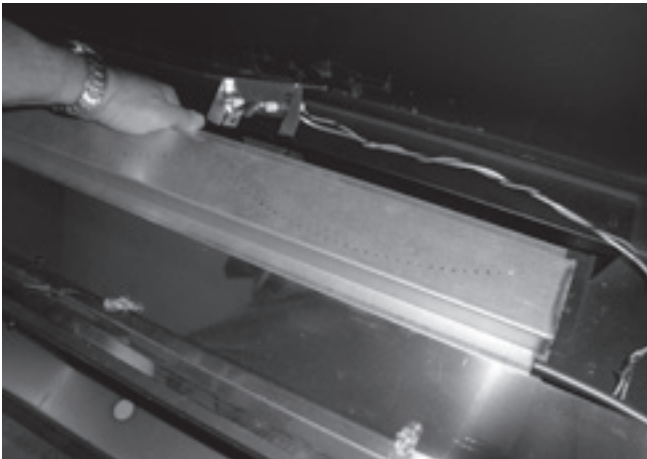

Figure 15

14. Locate the two internal Blower Access Cover plates. Using a $\frac{5}{16}$ -inch Hex drive socket, remove these two gasketed access plates, and set aside. **See Figures 16, 17, & 18.**

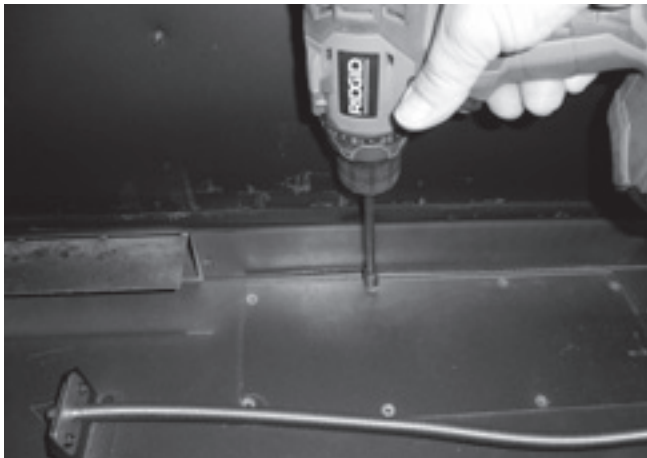

Figure 16

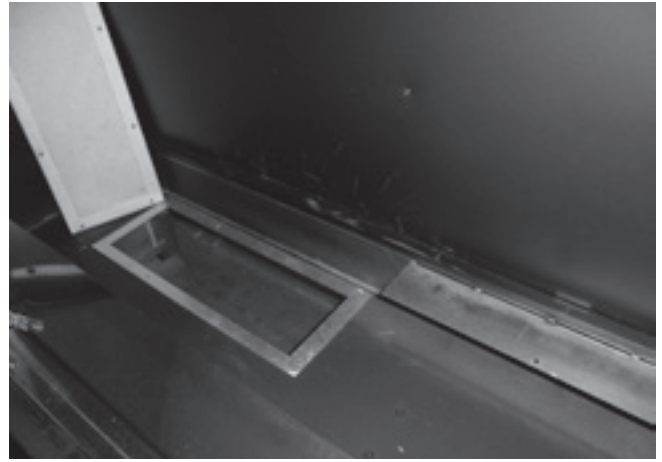

Figure 17

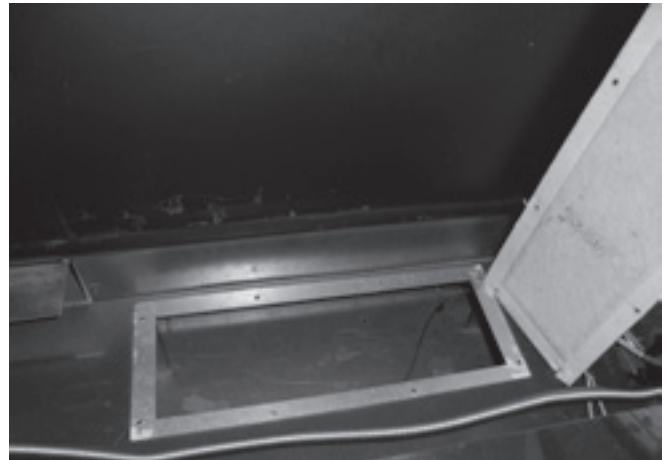

Figure 18

INSTALLATION OF THE BLOWER KIT

15. Set the two blower assemblies on the firebox bottom as shown in **Figure 19**.

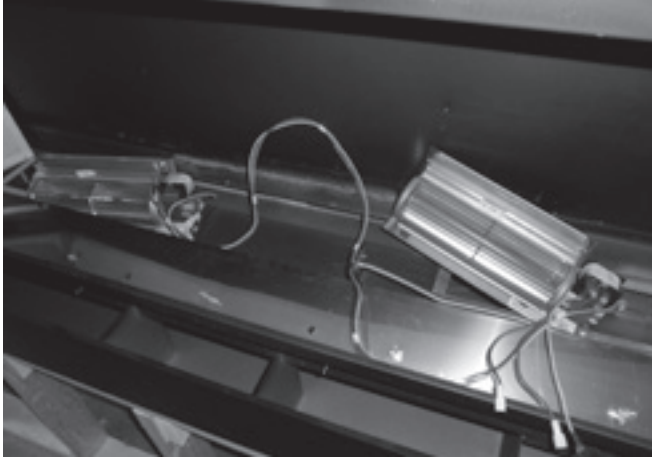

Figure 19

16. Carefully remove the two black wire leads, and the green ground wire lead, from the left hand blower motor only. **See Figure 20**.



Figure 20

17. Gently move the pilot/pilot bracket rearward out of the way.

⚠ CAUTION

Do not kink the pilot tubing.

18. Using gloves, insert the left hand blower assembly (without wires leads attached) down through the left hand rectangular cutout in the firebox bottom. Position the blower so the motor is to the right with the air discharge pointing upward. Set the blower on the bottom of the fireplace and also as far rearward as it can go. The magnets on the blower base bracket will retain the blower assembly in the correct position against the rear wall of the fireplace outer wrap. **See Figure 21**.

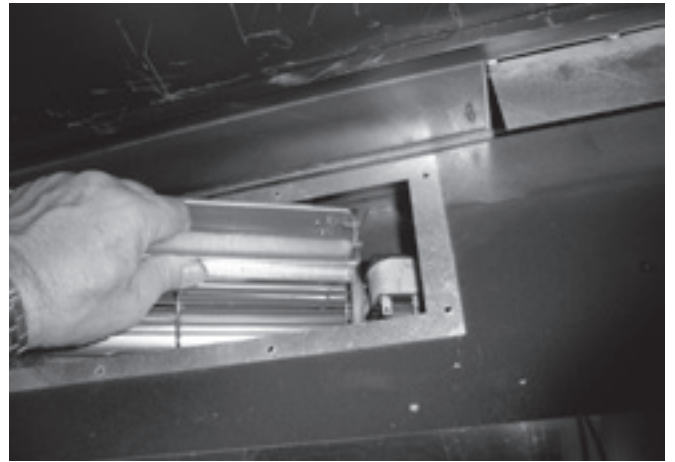

Figure 21

19. Next, install the right hand blower assembly. Place the ends of the disconnected wire leads removed from the left hand blower in step 15, down through the right hand rectangular access, then feed them across (next to the rear wrap) to the left hand blower motor. **See Figure 22**. Re-attach the black leads to the motor and green lead to the ground terminal. **See Figures 23 and 24**.



Figure 22

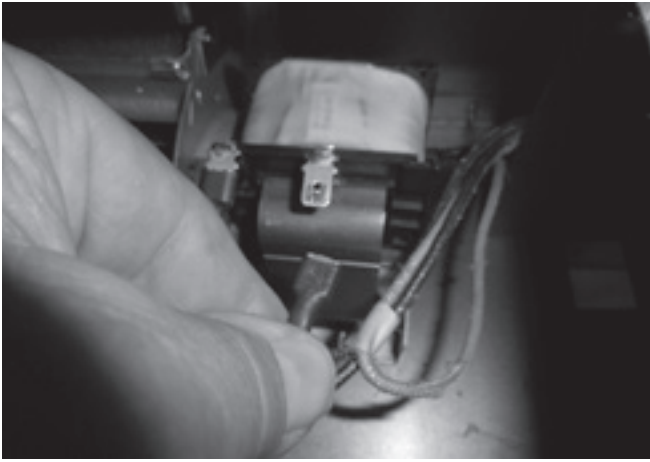

Figure 23

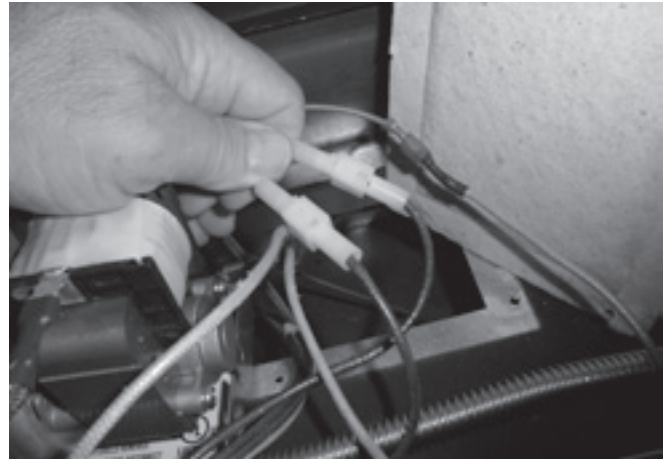

Figure 26

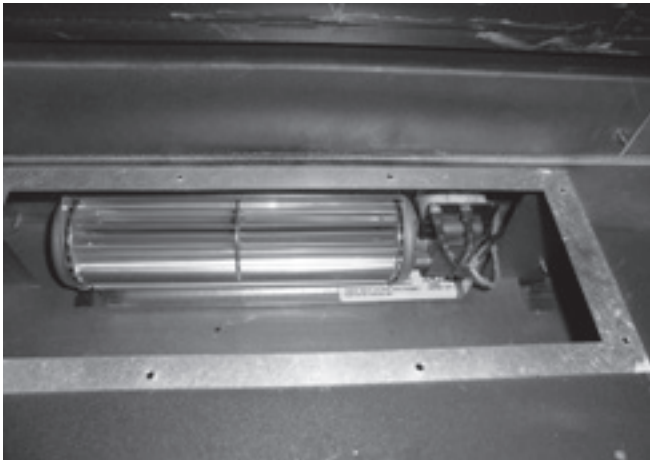

Figure 24

20. Looking down into the right hand cutout, locate two wires with white plastic connectors, and the green ground wire preattached to the fireplace bottom. **See Figure 25.** Connect these three wires to the mating right hand blower assembly wire connections. **See Figure 26.**

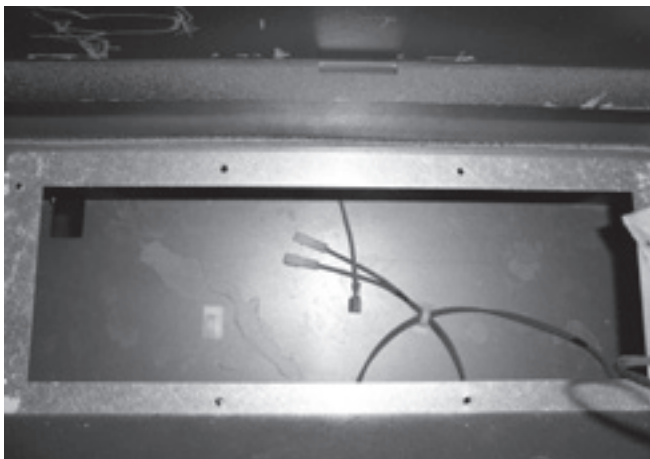

Figure 25

21. Once the connections have been made, lower the right hand blower assembly into the bottom of the fireplace with the motor to the right. All wiring should be routed in front of the blower assembly away from the blower wheel. Position the right hand blower on the bottom of the fireplace and as far rearward as it can go. The magnets on the back of the blower base bracket will retain the blower assembly in the correct position against the rear wall of the fireplace outer wrap. **See Figure 27.**

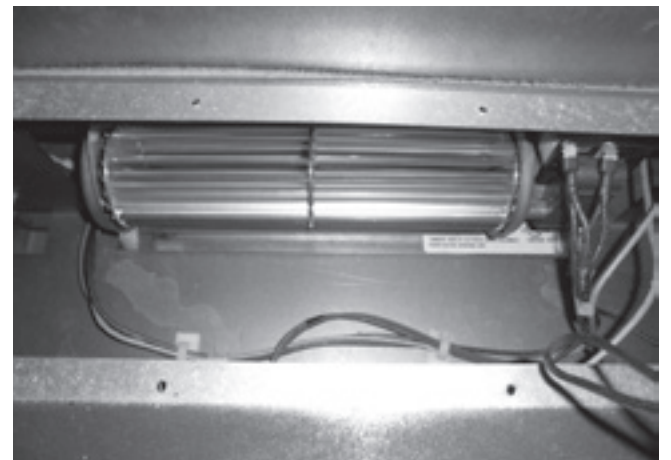
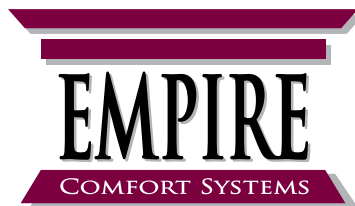

Figure 27

22. If electrical power is available to the fireplace, it is recommended that the blower accessory be tested to verify proper operation.
23. Re-install the two blower access cover plates.
24. Re-install the burner assembly. Align the air shutter with the orifice holder, then shift burner to the right. Re-secure with the two screws removed in step #11.
25. Re-attach the pilot/pilot bracket to the burner with two screws removed in step #10.
26. Re-install the rear baffle behind the burner assembly with the two screws removed in step #9.
27. Replace the burner screen. Position the rectangular cutout around the pilot bracket.
28. Re-install the burner cover assembly. It must be retained by the slots in the side wall brackets and set flat down on top of the burner screen.
29. Re-install the liner set. Refer to liner kit instructions if necessary.
30. Replace the two Accent Glass Panels in front of the burner area.
31. Replace the Light Cover.
32. Replace or install Decorative Crushed Glass media over the Burner Screen, Burner Cover, and Accent Glass panels.
33. Re-install the Glass Door and Barrier Screen assemblies.
34. Installation of the FBB20 Dual Blower kit is complete.



**Empire Comfort Systems Inc.
Belleville, IL**

If you have a general question
about our products, please e-mail
us at info@empirecomfort.com.

If you have a service or repair
question, please contact your dealer.

SINCE 1932

www.empirecomfort.com