



# INSTALLATION AND OPERATION GUIDE FOR

# OLDE WORLD BASKET

## Vented Decorative Appliance

For all models tested through PFS Corporation, to ANSI Z21.60-2003/CGA 2.26-2003, Decorative Appliance for Installation in Solid Fuel Burning Fireplaces. For model number and PFS seal refer to attached nameplate.

**Installation and service must be provided by a qualified installer, service agency or the gas supplier.**

**NOTE:** ADEQUATE FIREPLACE VENTILATION IS REQUIRED FOR SAFETY  
READ INSTRUCTIONS FULLY BEFORE INSTALLING OR OPERATING  
INSTALLER: LEAVE THESE INSTRUCTIONS WITH CONSUMER!

Olde World Basket sets are available with either a gas log or coal look. The gas logs are made with refractory materials while the coals are made of ceramic fiber. Each log is hand-finished to assure the most realistic, detailed log available. The coal is designed to achieve the glowing characteristics of real coal. The burner system is designed to burn like wood, with a smoky flame. For this reason, the set must be burned only in a fully vented, non-combustible fireplace with the damper completely open (In the Commonwealth of Massachusetts the damper must be either permanently welded in the fully open position or completely removed) and the chimney free of any obstructions or restrictions. The fireplace must be designed and approved to burn wood.

The realistic yellow flame produces carbon monoxide and soot. Under normal conditions, these products are exhausted up the chimney. If fumes or soot, from the gas burning, are evident in the room when the damper is fully open it indicates that the fireplace draft is defective. Do not operate your gas log set until the fireplace draft is corrected.

**FOR YOUR SAFETY**

Do not store or use gasoline or other flammable vapors and liquids in the vicinity of this or any other appliance.

---

**FOR YOUR SAFETY**

**WHAT TO DO IF YOU SMELL GAS**

1. Do not try to light any appliance.
2. Do not touch any electrical switch; do not use the phone in your building.
3. Immediately call your gas supplier from a neighbor's phone. Follow the gas supplier's instructions.
4. If you cannot reach your gas supplier, call the fire department.

---

**WARNING:** If the information in this manual is not followed exactly, a fire or explosion may result causing property damage, personal injury or loss of life.

It is the homeowner's responsibility to assure their fireplace has adequate draft

---

**RECOMMENDED BURN –IN PERIOD**

Olde World Basket gas logs are made of special refractory materials, which withstand high temperatures. One characteristic of this material is retention of moisture. For this reason, we recommend burning the logs for only fifteen minutes during the first burning. After allowing the logs to cool for at least one hour, the set can be burned for any length of time.

---

**WARRANTY**

Hargrove gas logs and coals carry a limited lifetime warranty against breakage in the original fireplace. Warranty does not include labor. Burners and grates are warranted for five years. Valves and pilot systems carry a two year limited warranty in the original fireplace. Hargrove Manufacturing Corp., will replace items during this period for the cost of shipping. See limited warranty information (pg. 12) for complete details.



## IMPORTANT INFORMATION

**WARNING: This appliance assembly contains burner orifices specifically for the input gas and Btu rating. Modifying or failure to use the factory orifice may cause property damage, personal injury or loss of life.**

1. Do not use a natural gas set with propane or a propane set with natural gas.
2. There are many different local codes for gas fire logs. The installation and the provision for combustion and ventilation air must conform to local codes and, or in the absence of local codes, with the National Fuel Gas Code ANSI Z223.1 or the CAN/CSA-B149.1 Installation Code.
3. Gas log sets must be installed by personnel qualified for installing gas appliances.
4. This appliance must be installed only in a solid-fuel burning fireplace with a working flue and constructed of non-combustible materials. Solid fuels are not to be burned in a fireplace where a decorative appliance has been installed.
5. A permanent free opening must be provided by either the fireplace chimney or chimney damper to vent flue gases. Any chimney damper must be fixed in a manner, which will maintain the permanent free opening at all times. Use Tables II and III to determine the minimum permanent free opening based on chimney height and the appliance Btu input rating. Refer to the Damper Stop section for additional directions.
6. The minimum free opening is based only on two factors; chimney height and Btu input rating. Many other factors affect the fireplace drafting. It is the homeowner's responsibility to assure their fireplace has adequate draft. If fumes or soot from the gas burning are evident in the room when the damper is fully open, it indicates that the fireplace draft is defective. Do not operate your gas log set until the fireplace draft is corrected. Consult your fireplace specialist.
7. A fireplace screen must be in place when the appliance is operating and, unless other provisions for combustion air are provided, the screen shall have an opening(s) for introduction of combustion air.
8. When glass fireplace doors are used, always operate gas log set with the glass doors fully open to allow for proper combustion air and to keep control valves from overheating.
9. The minimum inlet supply pressure for the purpose of input adjustment is 3.5 inches (natural gas) 8 inches (propane gas) in water column. The maximum inlet supply pressure is 10.5 inches (natural gas) 13 inches (propane gas) in water column.
10. The appliance and its individual shut-off valve must be disconnected from the gas supply piping system during any pressure testing of that system at test pressures in excess of 1/2 psig (3.5kPa). The appliance must be isolated from the gas supply piping system by closing its individual manual valve during pressure testing equal to or less than 1/2 psig (3.5kPa).
11. The fireplace chimney or venting system should be examined annually and cleaned as required by a qualified agency.
12. The appliance area is to be clear and free from combustible materials, gasoline and other flammable vapors and liquids.
13. After burning for several hours the logs become fragile and should not be handled. Knocking or rubbing logs can cause concrete to crumble and is not covered under the warranty.
14. To clean the logs, use a soft dry paintbrush for periodic dusting of the gas fire logs.

NOTE: In the Commonwealth of Massachusetts the damper must be either permanently welded in the fully open position or completely removed.

## FIREPLACE SIZES

Each Olde World Basket set requires a minimum 16-inch front opening height and minimum 10-inch depth. Table I below indicates the other critical dimensions.

<b>TABLE I</b>			
<u>Set Size</u>	<u>Minimum Front Opening Width</u>	<u>Minimum Depth</u>	<u>Minimum Height</u>
19"	22"	10"	16"

### TABLE II FACTORY BUILT FIREPLACES

Free opening area of chimney damper for venting combustion products from decorative appliances for installation in solid fuel burning fireplaces

Factory Built	Appliance Input Rate (kBTU/hr)			
	20	30	34	40
Chimney Height* (ft)	Minimum Opening** (sq. in.). (Minimum Diameter (in.))			
10	11.3	16.6	18.8 (5")	22.1
15	8.6	12.6	14.5 (5")	17.3
20	7.5	10.8	12.3 (4")	14.5
25	6.6	9.6	10.8 (4")	12.6
30	6.2	9.1	10.0 (4")	11.3
35	5.7	8	9.1 (3.5")	10.8
40	5.3	7.5	8.6 (3.5")	10.2

\* Height is from hearth to top of chimney and the minimum height is 10 ft  
 \*\* Chart shows minimum opening (sq. in.) for a given height and input rate

### TABLE III MASONRY BUILT FIREPLACES

Free opening area of chimney damper for venting combustion products from decorative appliances for installation in vented fireplaces.

Masonry Built	Appliance Input Rate (kBTU/hr)			
	20	30	34	40
Chimney Height* (ft)	Minimum Opening** (sq. in.)			
6	17.6	25.7	28.9	33.8
8	16.5	23.7	26.7	31.2
10	15.1	21.7	24.5	28.7
15	14.1	19.9	22.4	26.1
20	12.9	18.5	20.6	23.7
30	12.2	16.9	18.8	21.6

\* Height is from hearth to top of chimney and the minimum height is 6 ft  
 \*\* Chart shows minimum opening (sq. in.) for a given height and input rate

# INSTALLATION

**NOTE:** Hargrove Olde World Basket sets are to be installed by qualified personnel only. Failure to follow these instructions may cause a fire or explosion resulting in property damage, personal injury or loss of life.

Installer: Please leave these instructions with the homeowner.

Owner: Please retain these instructions for future reference.

## BURNER INSTALLATION

**IMPORTANT:** Before installing in a solid-fuel burning fireplace, the chimney flue and firebox must be free of soot, creosote, ashes and loose paint. Removal of these items should be performed a qualified chimney cleaning company.

1. Turn the gas supply **OFF**.
2. Turn **OFF** all electrical power to blower (if applicable) before installing, servicing or removing appliance.
3. The gas supply line should be ½" Inside Diameter (ID) up to 30 feet and ¾" for longer distances.
4. Remove the burner and basket from the box. The basket and burner media can be placed aside for later installation.
5. Center the burner from side to side and position it in the center of the firebox. Ideally, the burner will be aligned directly under the flue damper.
6. Use the 3/8" flex connector to connect gas supply line to the regulator. (see Fig. 1)

**Regulator Connection**

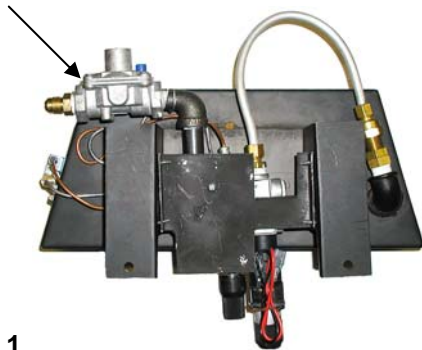

**Fig.1**

7. Verify that connections are tight, then turn on the gas and check each connection using a soap and water solution. **DO NOT USE AN OPEN FLAME FOR LEAK TESTING.** Any leaks must be corrected prior to proceeding with installation.
8. Determine the valve system that is installed on the appliance, then proceed with lighting the pilot. Refer to "LIGHTING INSTRUCTIONS" section pages 10-11. Check the pilot flame and main burner operation prior to proceeding with the burner media and log or coal installation (see Fig. 3).
9. Pilot flame height is preset at the factory and will not normally require adjustment. If field adjustment is required, locate the pilot adjustment screw and turn clockwise for decreased pilot flame or counter-clockwise for increased pilot flame (see LIGHTING INSTRUCTIONS section for pilot adjustment screw location). The upper 1/3 of the thermocouple/thermopile should be engulfed in the pilot flame.

**Thermocouple**

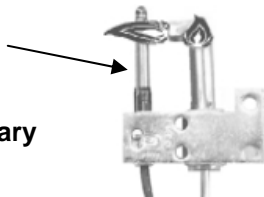
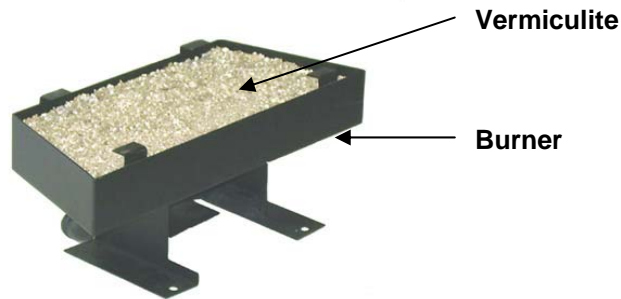

**Fig. 3  
Manual Safety & Rotary  
Pilot**

## BURNER MEDIA

1. Locate the bag of vermiculite(white granule material). Open the bag and evenly fill the entire burner pan area leaving a ¼” space empty at the top of the burner.

### Step 1



## DECORATIVE BASKET

1. Refer to the Basket Assembly Instructions to put the Decorative Basket together.
2. Place the assembled basket over the burner in the fireplace (see Fig, 4 & 5)
3. Proceed with Log or Coal installation (pg. 6-7)

Fig. 4

Top View

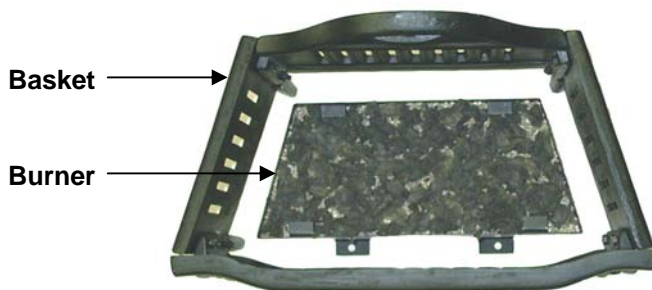
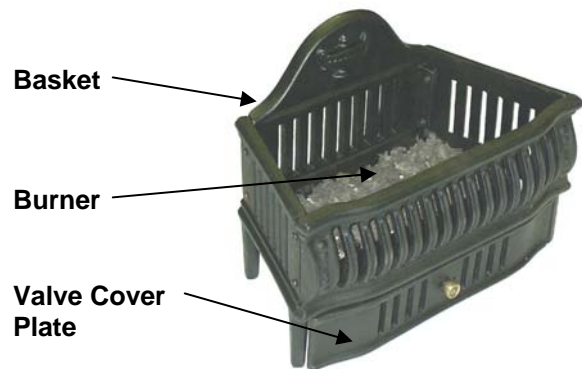

Fig. 5

Front Angle View



## DAMPER STOP INSTALLATION

Attach the damper stop clamp to the fireplace damper blade. Position the clamp to prevent full closure of the fireplace damper blade (see Fig. 6).

If the damper stop provided does not fit, the installer shall install a permanent damper stop that will keep the damper open to a minimum of opening as determined in Table II or III.

**CAUTION**  
**THE DAMPER MUST BE FULLY OPEN**  
**WHEN OPERATING THE GAS LOGS!**

**IMPORTANT: In the Commonwealth of Massachusetts the damper must be either permanently welded in the fully open position or completely removed.**

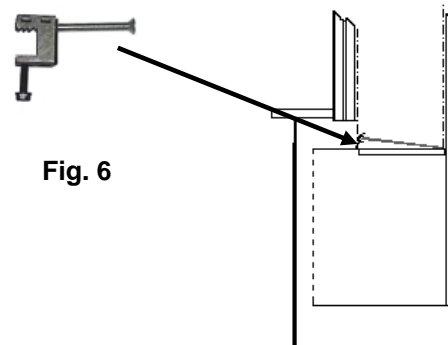

## IMPORTANT SAFEGUARDS

1. To avoid personal injury, do not touch hot surfaces when the appliance is operating. Surfaces include: grate, burner, logs, coals and opening of the fireplace.
2. Do not burn real wood or other materials including paper or food products with the log set.
3. Closely supervise children when the appliance is being operated.

## CLEANING and INSPECTION

1. Annual inspection and cleaning should be
2. performed by dealer or qualified personnel.
3. Allow logs or coals to cool completely before cleaning.
4. Logs or coals may be cleaned by lightly brushing with a soft bristle brush.
5. Verify flame pattern and log placement for proper operation after cleaning.

# Coal Installation



**Coal Matrix - Top View**

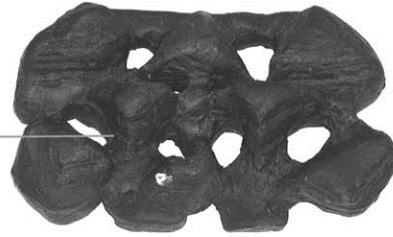

**Front**



**Triangular Piece Placement**

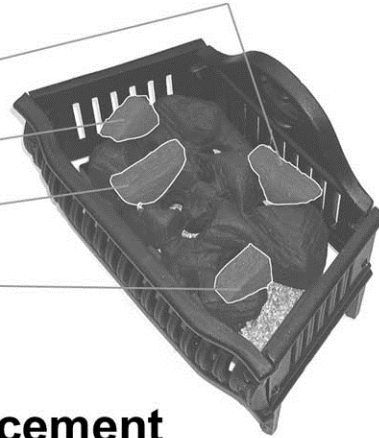

**Square Piece Placement**

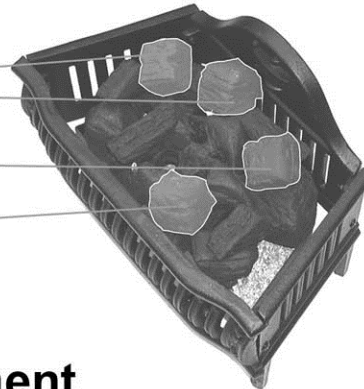

**OBC08  
MATRIX WITH 8 COALS**

**Completed  
Assembly**





# Log Installation

1



**Burner Media**

2

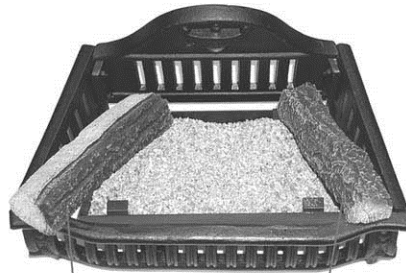

**Outer Logs**

3

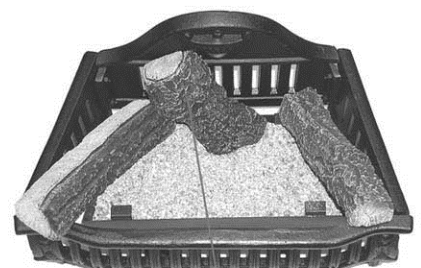

**Rear Log**



4

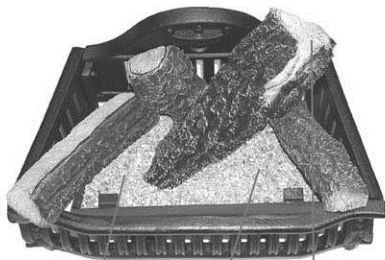

**Right Front Log**

**OBL05  
5 LOGS**

5

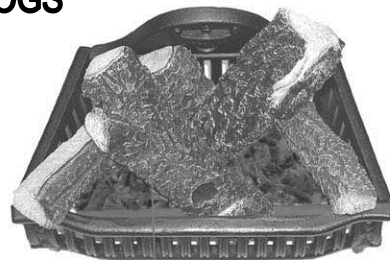

**Left Front Log  
(completed assembly)**

**Front View of  
Completed Assembly**

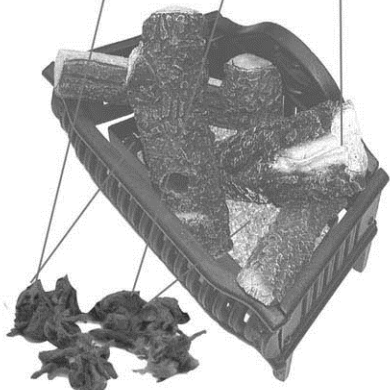

**Embers**



**(lower cover omitted for clarity)**

# PARTS LIST for MANUAL SAFETY PILOT VALVE (NG & LP)

When ordering parts provide gas type and model number.

ITEM	DESCRIPTION	QTY	OB(CO, LO)19(N, P)1B
A.	Burner	1	OB-14
B.	Basket (not pictured)	1	OG19
C.	Manual Pilot Valve	1	CPC-C
D.	Thermocouple Assembly (NG)	1	RSTPB-18
	Thermocouple Assembly (LP)	1	RSTPB-18LP
E.	3/8" Male X 5/16" Compression	1	68-0506
F.	3/8" Female X 5/16" Compression	1	66-0506
G.	3/8" Black Elbow	1	SE-6
H.	3/8" X 1 1/2" Pipe Nipple	1	N-6X1.5
I.	Regulator (NG)	1	REG 4
	Regulator (LP)	1	REG 10
J.	3/8" Brass Union	1	48-6
K.	3/8" Air Mixer (NG)	1	AM 3/8 X 3/8 #33
	3/8" Air Mixer (LP)	1	AM 3/8 X 3/8 #51
L.	3/8" Air Mixer Nut (NG only)	1	AM-N 3/8
M.	Flex Connector	1	FC-16
N.	5/16" Tubing	1	OWB-TUBE-C
O.	Valve Bracket	1	OB-VB
P.	Pilot Screws	2	10-32X1/4"
Q.	Screws	4	10X1/2"
R.	Valve Mounting Screws	1	10-24X3/4"
	*Damper Stop (Not pictured)	1	DS
	*Vermiculite (Not pictured)	1	VM
	*Embers (included only with logs - not pictured)	1	RW
	*1/2" Female X 3/8" Flare brass (Attach to the incoming gas line)	1	46-6-8

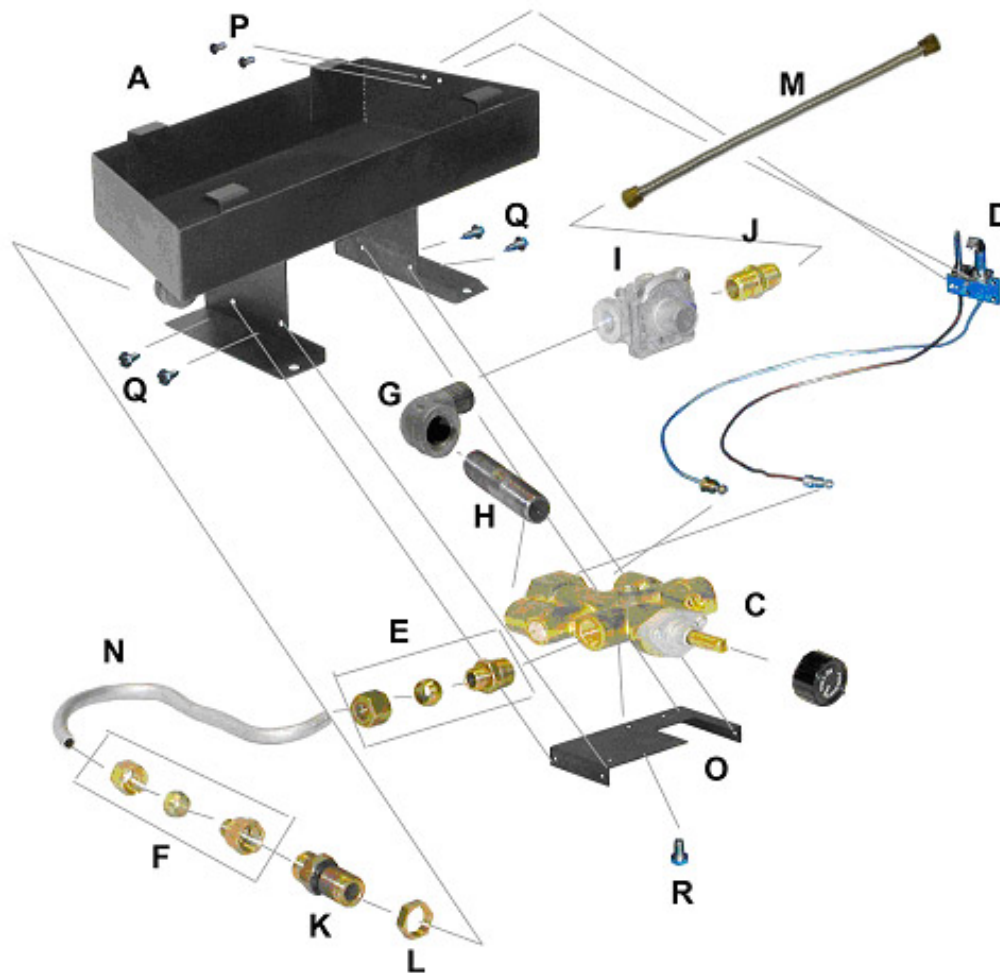



# PARTS LIST for ROTARY SAFETY PILOT VALVE (NG & LP)

When ordering parts provide gas type and model number.

<u>ITEM</u>	<u>DESCRIPTION</u>	<u>QTY</u>	<u>OB(CO. LO)19(N, P)1F</u>
A.	Burner	1	OB-14
B.	Basket (Not pictured)	1	OG19
C.	Rotary Pilot Valve	1	GV24-B1AOAOG
D.	Thermocouple Assembly (NG)	1	RSTPB-18
	Thermocouple Assembly (LP)	1	RSTPB-18LP
E.	3/8" Male X 5/16" Compression	1	68-0506
F.	3/8" Female X 5/16" Compression	1	66-0506
G.	3/8" Black Elbow	1	SE-6
H.	3/8" X 2 1/2" Pipe Nipple	1	N-6X2.5
I.	Regulator (NG)	1	REG 4
	Regulator (LP)	1	REG 10
J.	3/8" Brass Union	1	48-6
K.	3/8" Air Mixer (NG)	1	AM 3/8 X 3/8 #33
	3/8" Air Mixer (LP)	1	AM 3/8 X 3/8 #51
L.	3/8" Air Mixer Nut (NG only)	1	AM-N 3/8
M.	Flex Connector	1	FC-16
N.	5/16" Tubing	1	OWB-TUBE-R
O.	Valve Bracket	1	OB-VB
P.	Pilot Screws	2	10-32X1/4"
Q.	Screws	4	10-1/2"
R.	Valve Mounting Screws	2	10-32X1/4"
S.	Valve Gas Plug	1	SKC-C PLUG
T.	Servo Motor (Optional)	1	SKS
	*Damper Stop (Not pictured)	1	DS
	*Vermiculite (Not pictured)	1	VM
	*Embers (included only with logs - not pictured)	1	RW
	*1/2" Female X 3/8" Flare brass (Attach to the incoming gas line)	1	46-6-8

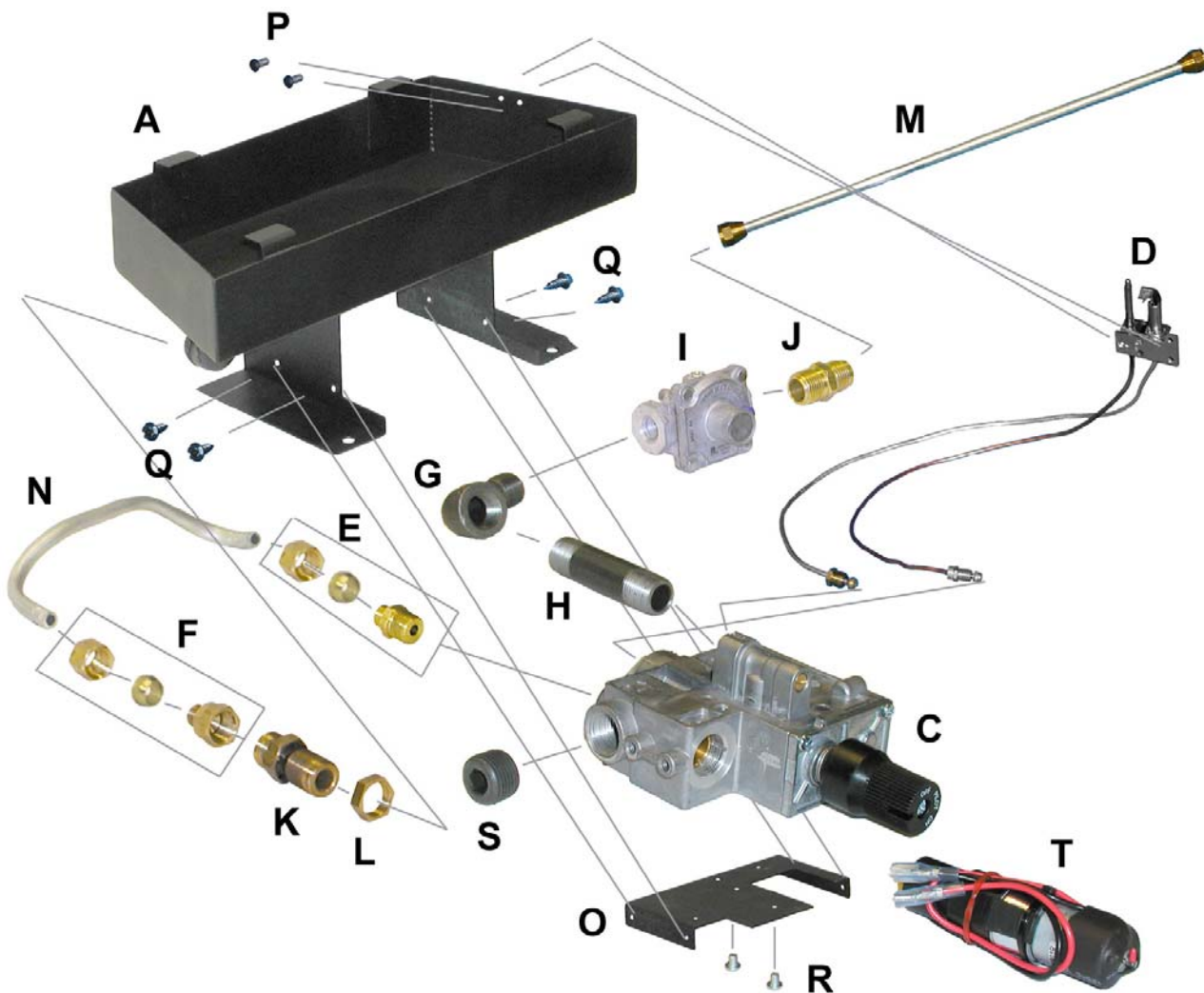

## FOR YOUR SAFETY READ BEFORE LIGHTING

**WARNING:** If you do not follow these instructions exactly, a fire or explosion may result causing property damage, personal injury or loss of life.

- A. This appliance has a pilot, which must be lit by hand. When lighting the pilot, follow these instructions exactly.
- B. **BEFORE LIGHTING** smell all around the appliance area for gas. Be sure to smell next to the floor because some gas is heavier than air and will settle on the floor.
- C. Use only your hand to push in or turn the gas control knob. Never use tools. If the knob will not push in or turn by hand, do not try to repair it. Call a qualified service technician.
- D. Do not use this appliance if any part has been under water. Immediately call a qualified service technician to inspect the appliance and to replace any part of the control system and any gas control, which has been underwater.

### WHAT TO DO IF YOU SMELL GAS:

1. Do not try to light any appliance.
2. Do not touch any electric switch; do not use any phone in your building.
3. Immediately call your gas supplier from a neighbor's phone. Follow the gas supplier's instructions.
4. If you cannot reach your gas supplier, call the fire department.

## LIGHTING INSTRUCTIONS for SAFETY PILOT VALVE

1. STOP! Read the safety information above on this label.
2. Push in gas control knob slightly and turn clockwise to "OFF". 

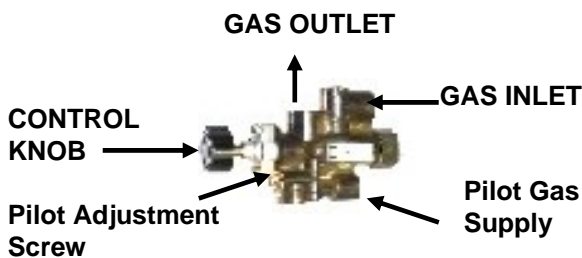

**NOTE:** Knob cannot be turned from "PILOT" to "OFF" unless knob is pushed in slightly. Do not force.

3. Wait five (5) minutes to clear out any gas. If you then smell gas, STOP! Follow "B" in the safety information above. If you don't smell gas, go to next step.

4. Find pilot – follow metal tube from the gas control behind the burner pan.

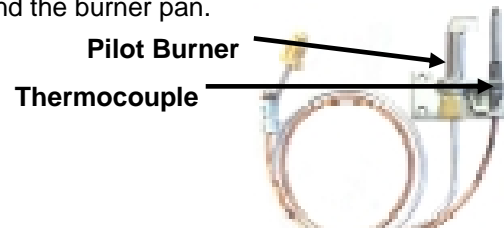

5. Turn knob on gas control counter-clockwise to "PILOT".
6. Push in control knob all the way and hold in. Immediately light the pilot with a match. Continue to hold the control knob in for about one minute after the pilot is lit. Release knob and it will pop back up. Pilot should remain lit. If it goes out, repeat steps 3 – 7.
- \* If knob does not pop up when released, stop and immediately call your service technician or gas supplier.
- \* If the pilot will not stay lit after several tries, turn the gas control knob to "OFF" and call your service technician or gas supplier.
7. Turn gas control knob counterclockwise to "ON". 

## TO TURN OFF GAS TO APPLIANCE

1. Turn knob clockwise from "ON" position to the "PILOT" position. Push in the gas control knob slightly and turn clockwise to "OFF".  Do not force knob.

## FOR YOUR SAFETY READ BEFORE LIGHTING

**WARNING:** If you do not follow these instructions exactly, a fire or explosion may result causing property damage, personal injury or loss of life.

- A. This appliance has a pilot, which must be lit by hand. When lighting the pilot, follow these instructions exactly.
- B. **BEFORE LIGHTING** smell all around the appliance area for gas. Be sure to smell next to the floor because some gas is heavier than air and will settle on the floor.
- C. Use only your hand to push in or turn the gas control knob. Never use tools. If the knob will not push in or turn by hand, do not try to repair it. Call a qualified service technician.
- D. Do not use this appliance if any part has been under water. Immediately call a qualified service technician to inspect the appliance and to replace any part of the control system and any gas control, which has been underwater.

### WHAT TO DO IF YOU SMELL GAS:

1. Do not try to light any appliance.
2. Do not touch any electric switch; do not use any phone in your building.
3. Immediately call your gas supplier from a neighbor's phone. Follow the gas supplier's instructions.
4. If you cannot reach your gas supplier, call the fire department.

## LIGHTING INSTRUCTIONS FOR ROTARY VALVE

1. STOP! Read the safety information above on this label.
2. Push in control knob slightly and turn clockwise to "OFF".
4. Find pilot – follow metal tube from the gas control behind the burner pan.

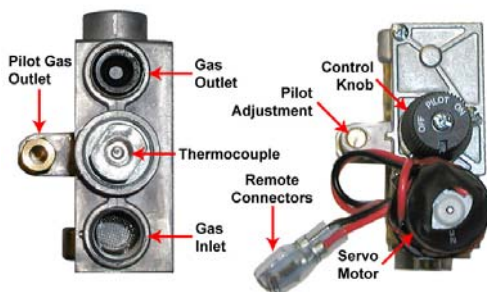

**NOTE:** Knob cannot be turned from "PILOT" to "OFF" unless knob is pushed in slightly. Do not force.

3. Wait five (5) minutes to clear out any gas. If you then smell gas, STOP! Follow "B" in the safety information above. If you don't smell gas, go to next step.

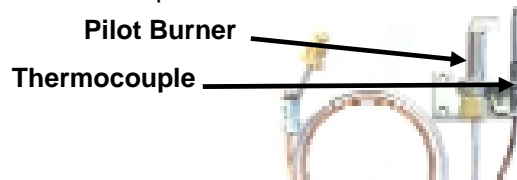

5. Turn knob on gas control counter-clockwise to "PILOT".
6. Push in control knob all the way and hold in. Immediately light the pilot with a match. Continue to hold the control knob in for about one minute after the pilot is lit. Release knob and it will pop back up. Pilot should remain lit. If it goes out, repeat steps 3 – 7.
- \* If knob does not pop up when released, stop and immediately call your service technician or gas supplier.
- \* If the pilot will not stay lit after several tries, turn the gas control knob to "OFF" and call your service technician or gas supplier.
7. Turn gas control knob counterclockwise to "ON".
8. Use the remote control to reach the desired flame height.

## TO TURN OFF GAS TO APPLIANCE

1. Turn knob clockwise from "ON" position to the "PILOT" position. Push in the gas control knob slightly and turn clockwise to "OFF". Do not force knob.

## LIMITED WARRANTY

### Refractory Logs

Hargrove gas logs and coals carry a limited lifetime warranty against any manufactured defect or breakage. A replacement will be available from the dealer at which the appliance was purchased. This warranty does not cover breakage caused by excessive handling once installed and fired.

### Burner & Grate

If the burner or grate fails due to deterioration within five (5) years of the verified purchase date, a free replacement will be made available from the dealer at which the appliance was purchased.

### All Other Parts

If any assembled part should fail to operate or be found defective within two (2) years of the verified purchase date, a replacement will be available from the dealer at which the appliance was purchased.

## WHAT IS NOT COVERED

1. Removal and reinstallation costs.
2. Labor costs for replacement or repairs.
3. Transportation or shipping cost.
4. The cost of a service call to diagnose trouble.
5. Painted Surfaces.
6. Damage or defect caused by improper installation, accident misuse, abuse, or alteration.
7. Replacement of rusted burner or combustion chamber resulting from improper storage of the appliance.

## LIMITATIONS AND EXCLUSIONS

1. No one has authority to add to or vary this limited warranty, or to create for Hargrove Manufacturing Corporation any other obligation or liability in connection with this appliance.
2. Any implied warranty applicable to this appliance is limited in duration to the same period of time as this written Warranty. Some states do not allow limitations on how long an implied warranty lasts, so the above limitations may not apply to you.
3. HARGROVE MANUFACTURING CORPORATION WILL NOT BE LIABLE FOR INCIDENTAL, CONSEQUENTIAL, SPECIAL OR CONTINGENT DAMAGES YOU MIGHT SUFFER AS A RESULT OF ITS BREACH OF THIS Written WARRANTY OR ANY IMPLIED WARRANTY. Some states do not allow the exclusion or limitation of incidental or consequential damages, so the above limitations or exclusion may not apply to you.
4. This warranty applies only to the original purchase and may not be transferred.
5. If you cannot verify the purchase date of the appliance, the warranty period will begin on the date of which the appliance was manufactured.
6. Replacement or repair parts are warranted for the remaining period of the original part warranty. Warranty parts must be obtained through authorized dealers of this product who will provide original factory replacement parts. Failure to use original factory replacement parts voids this warranty.

## YOUR DUTIES

This appliance must be installed by a qualified installer, operated and maintained in accordance with all applicable codes and the instructions furnished with the appliance. You must provide a receipt verifying the purchase date of the appliance when making a warranty claim with the dealer from which the appliance was purchased.

This warranty gives you specific legal rights, and you may also have other rights, which vary from state to state.

**CONTACT INFO: Hargrove Manufacturing Corp.**  
**Tele: (800) 725-4166**