

GF- CART

Installation Instructions

1- Join the Gas Cylinder holder on down shelf with 8 M4 screw

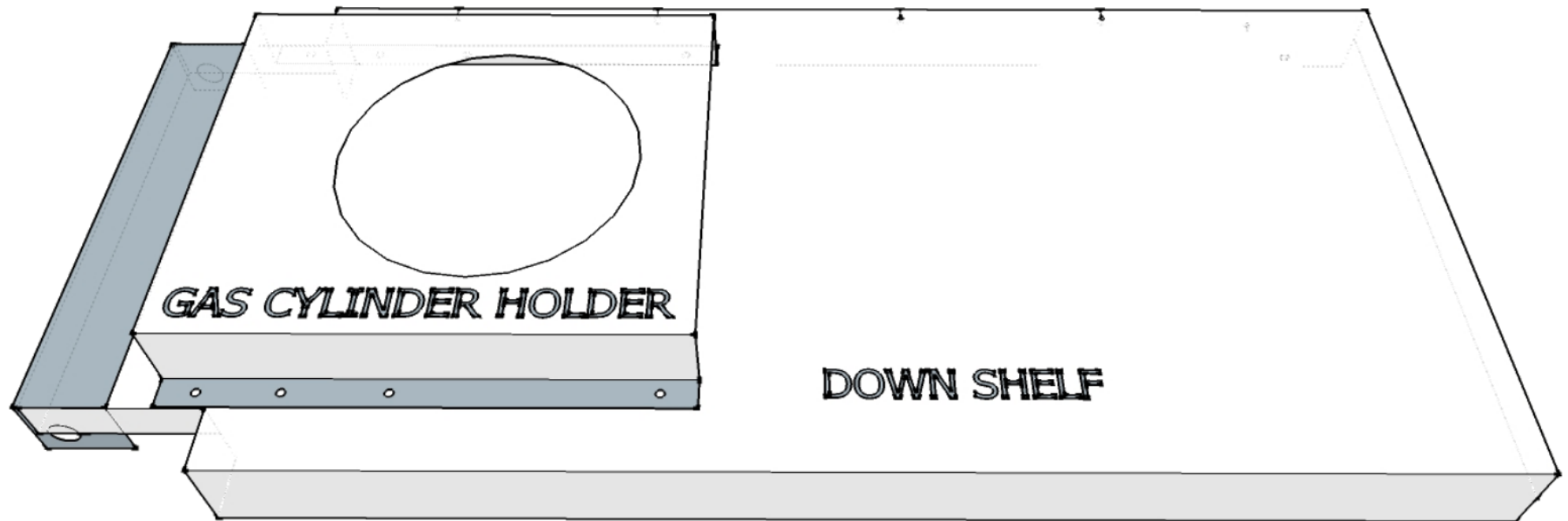

2- LEFT SIDE :use the 7 M4 screw

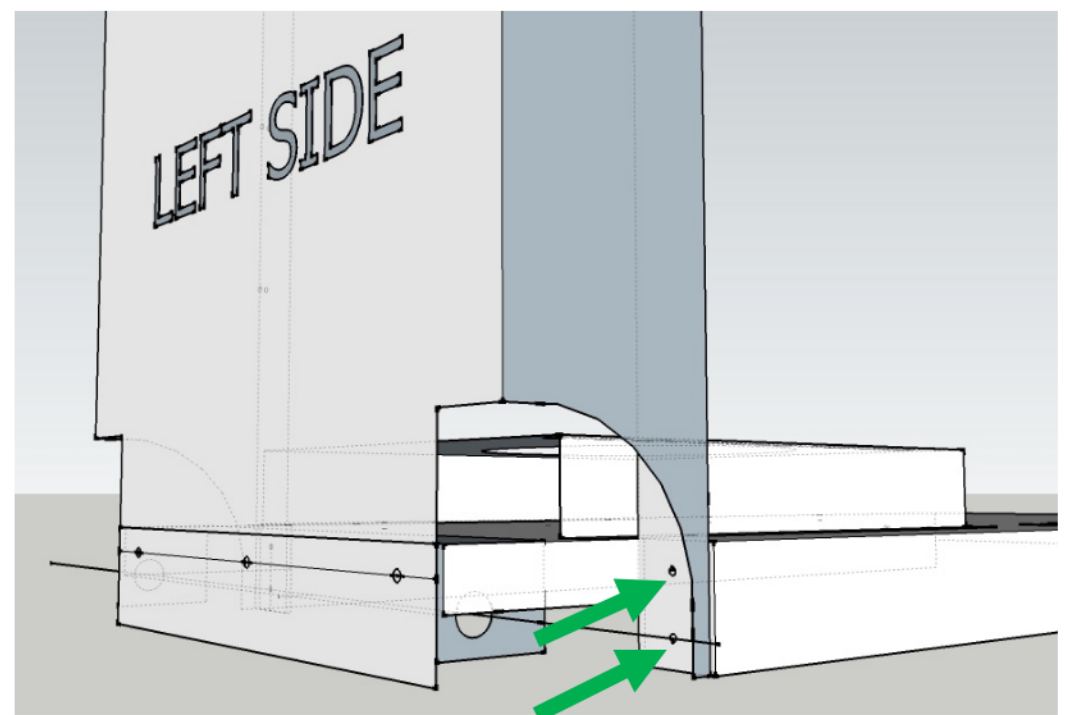
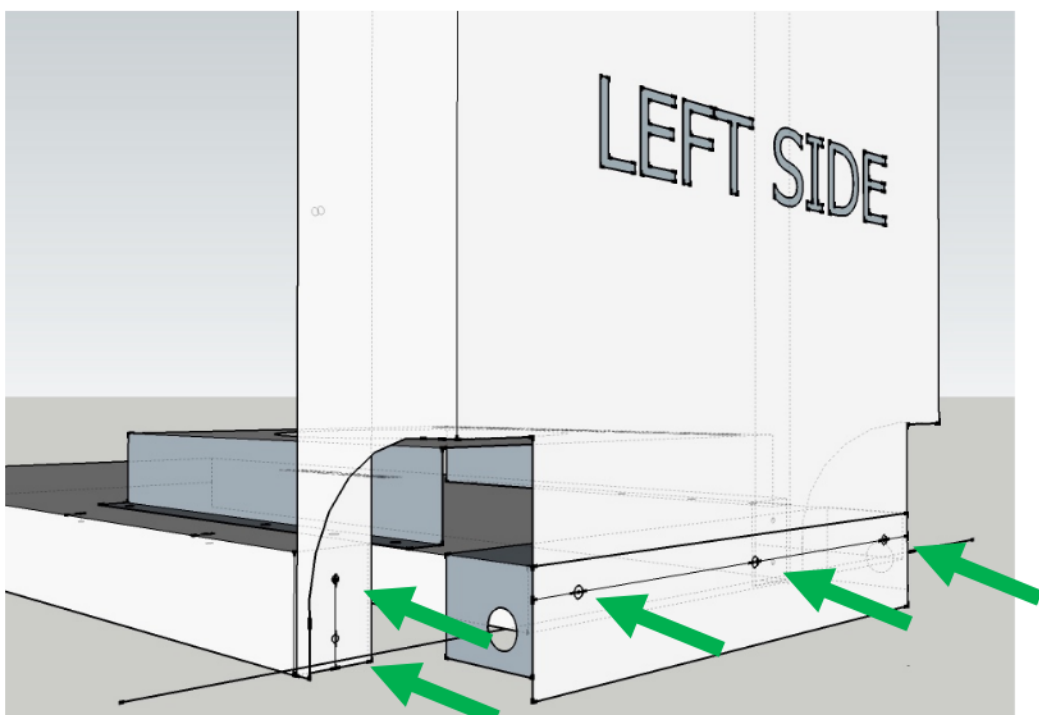
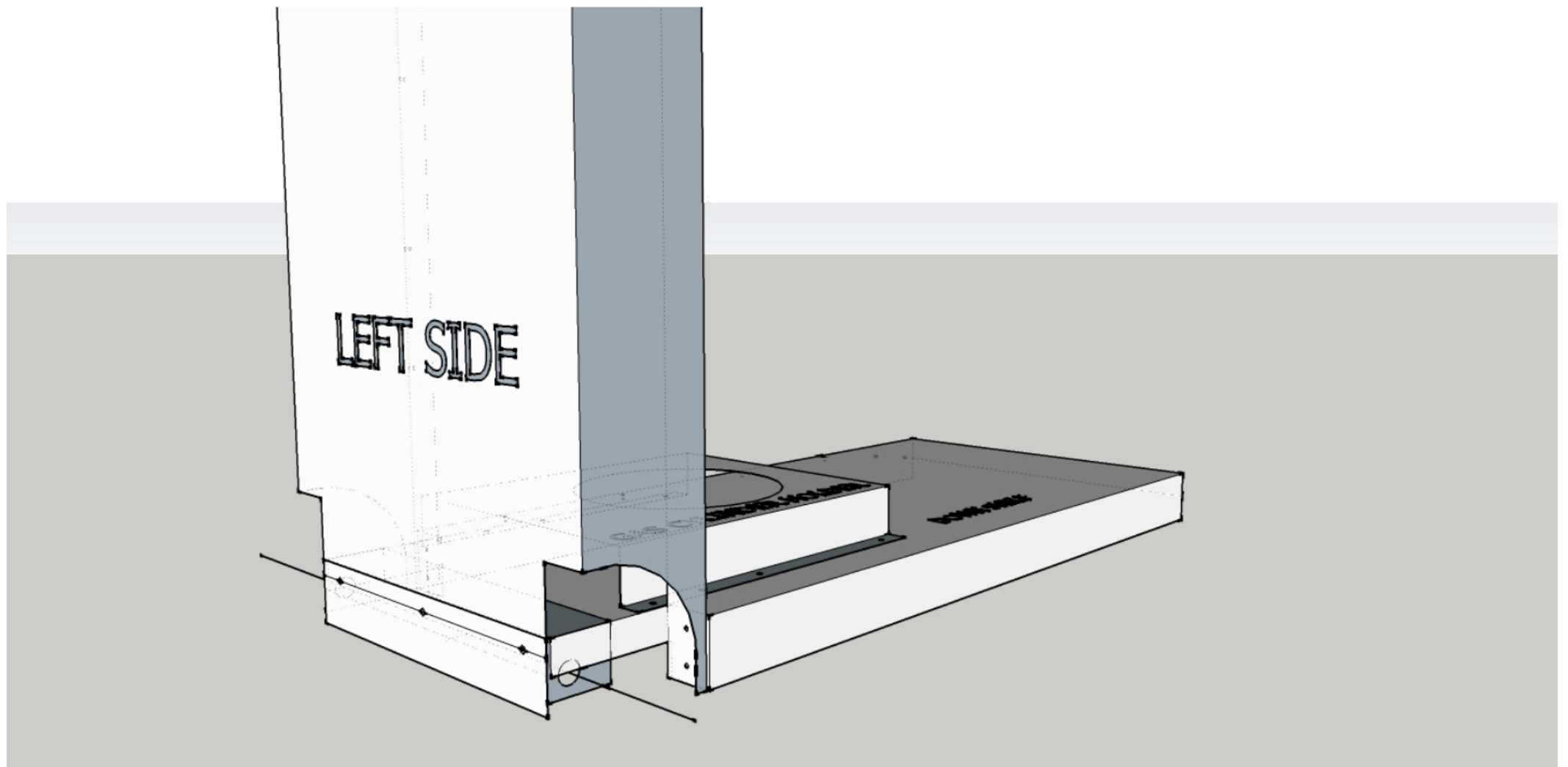

4- WHEELS :fix them with 2 M12x80 screws + Nut
Be carrefull : Tighten the faster **STRONG**

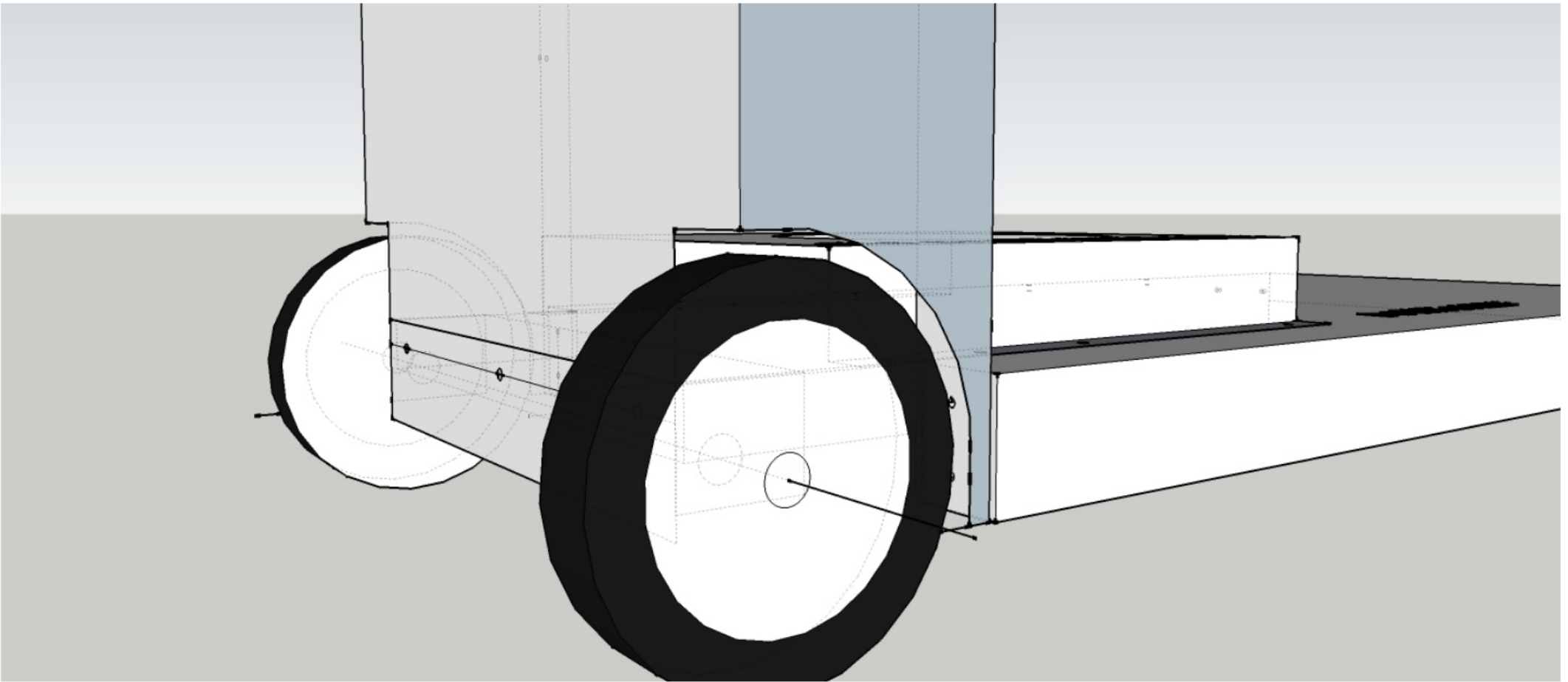

5- RIGHT SIDE :use 7 M4 screws

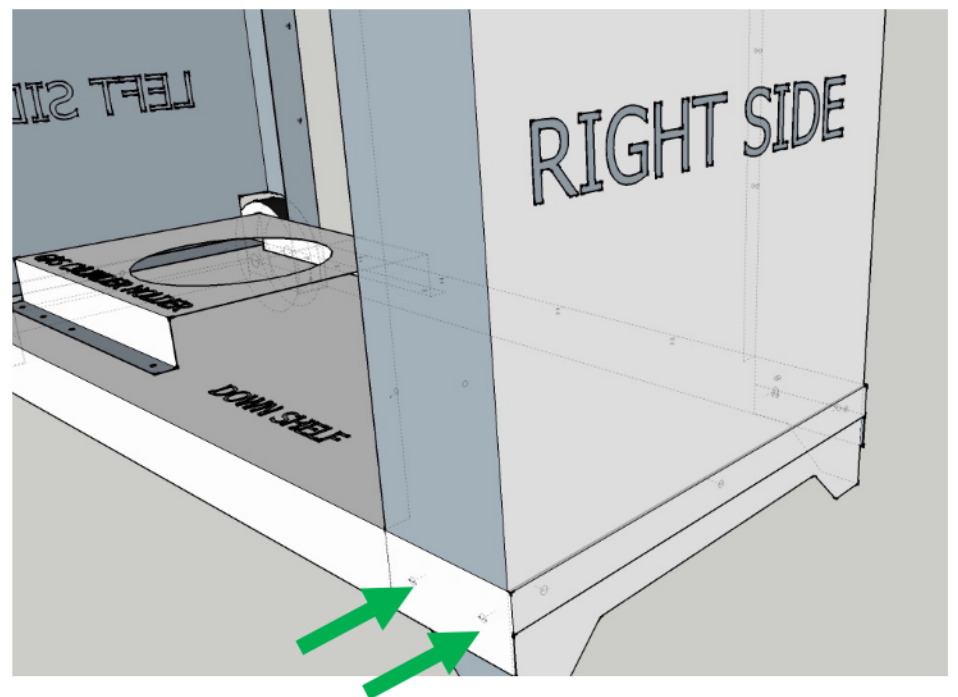
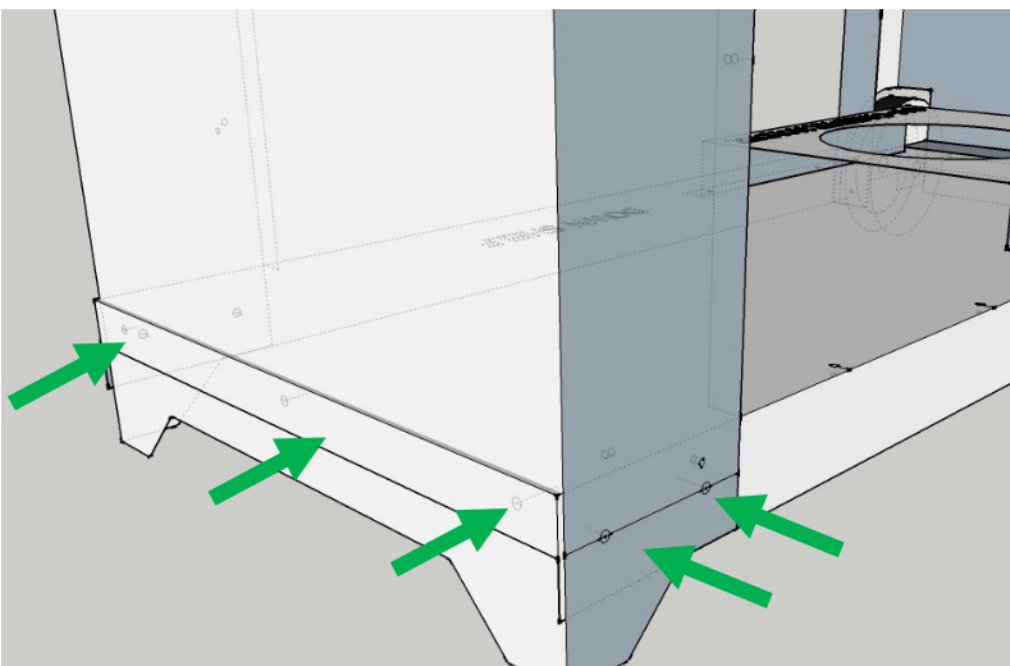
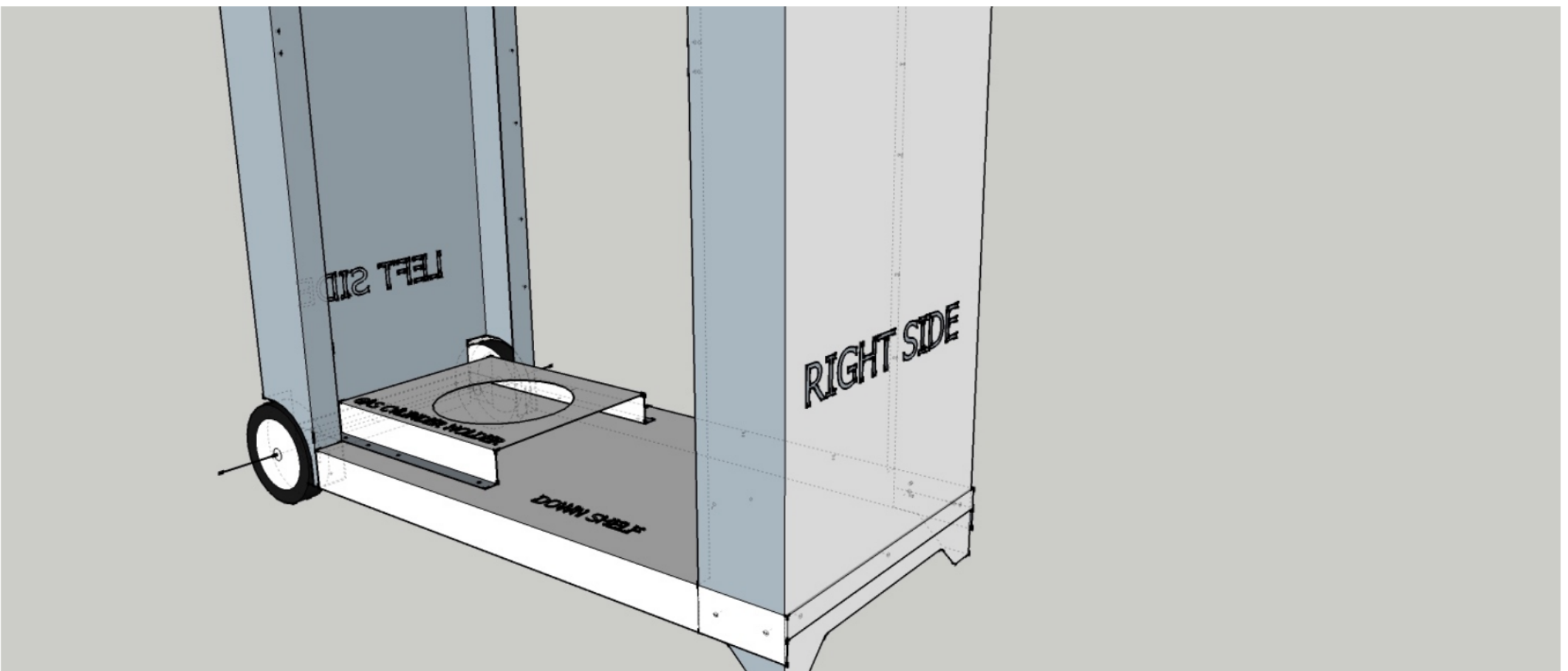

6- BACK :Add left and right back fix them with 13 M4 screws

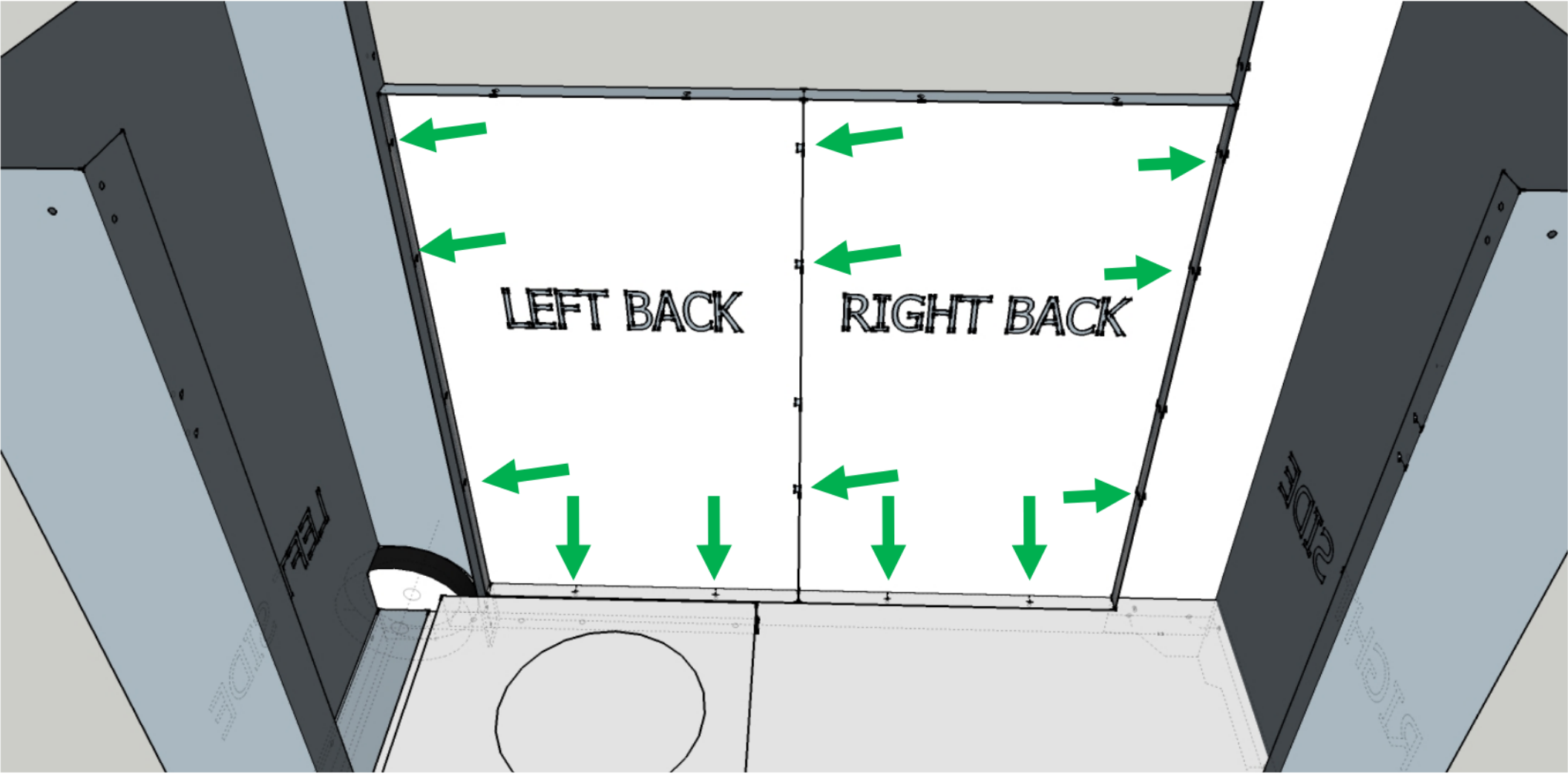

7- BACK :Add the top back, fix it with 8 M4 screws

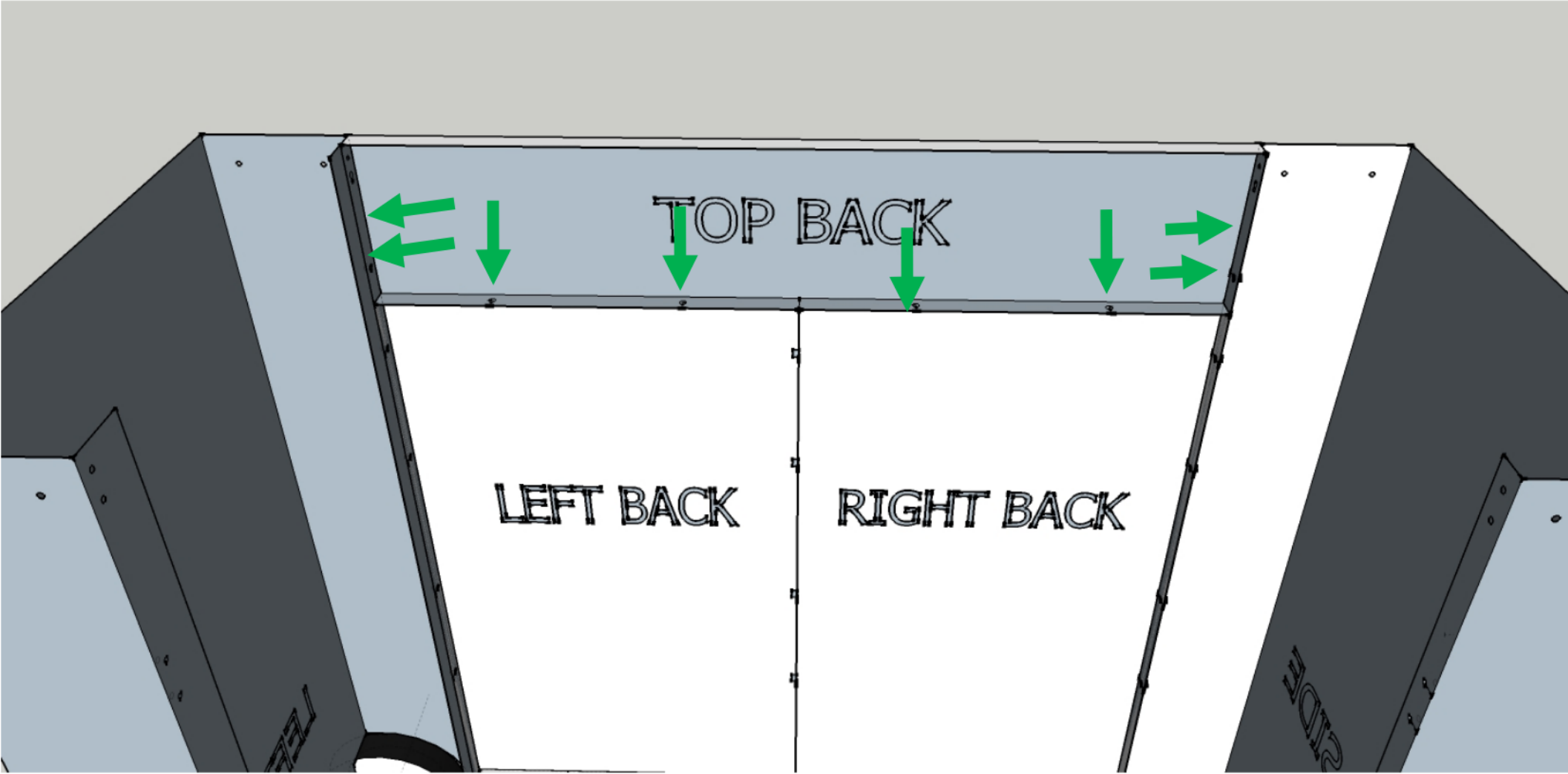

8-1 TABLET :Add the left tablet, fix it with 10 M4 screws

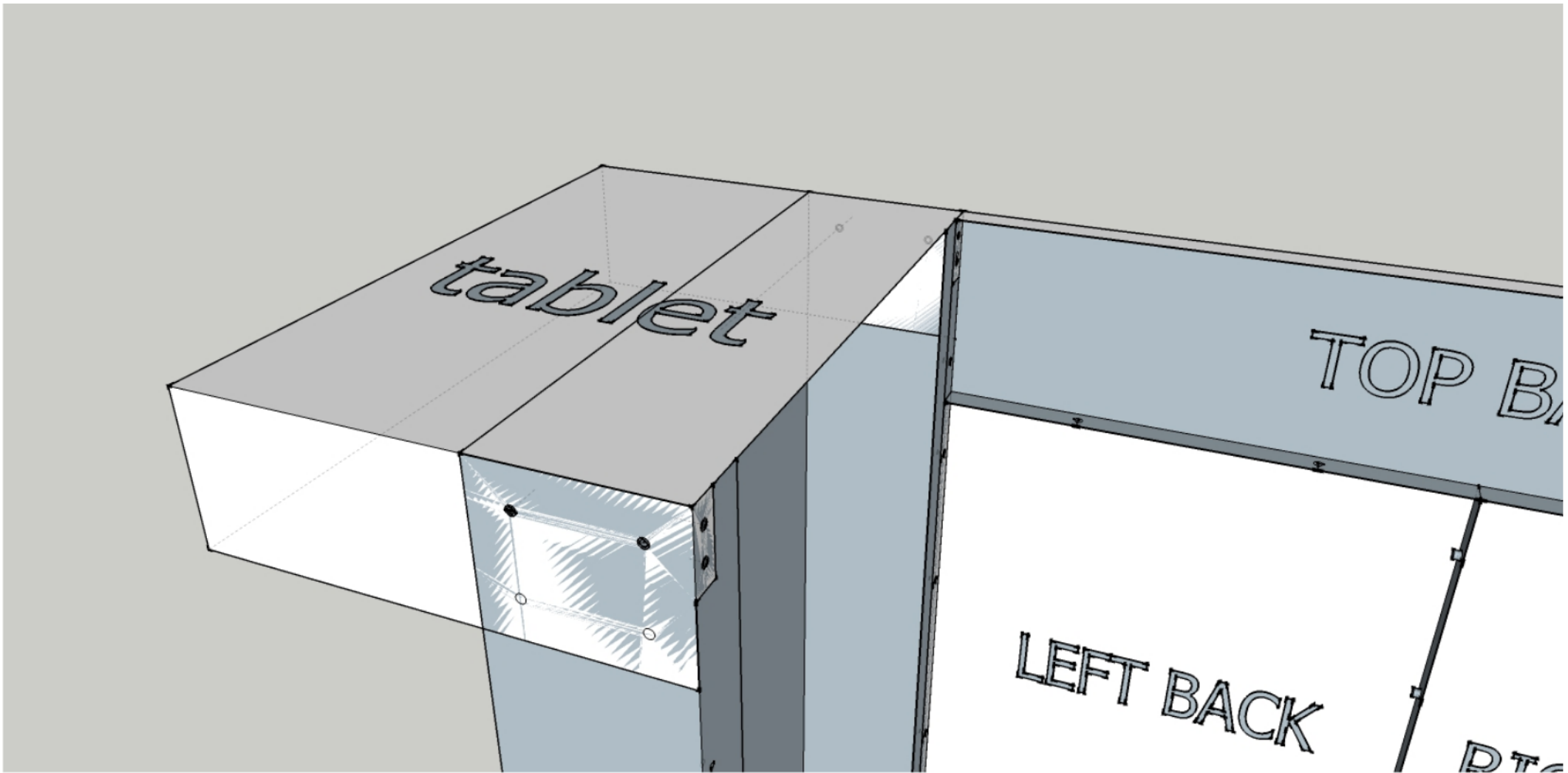

8-2 TABLET :Add the right tablet, fix it with 10 M4 screws

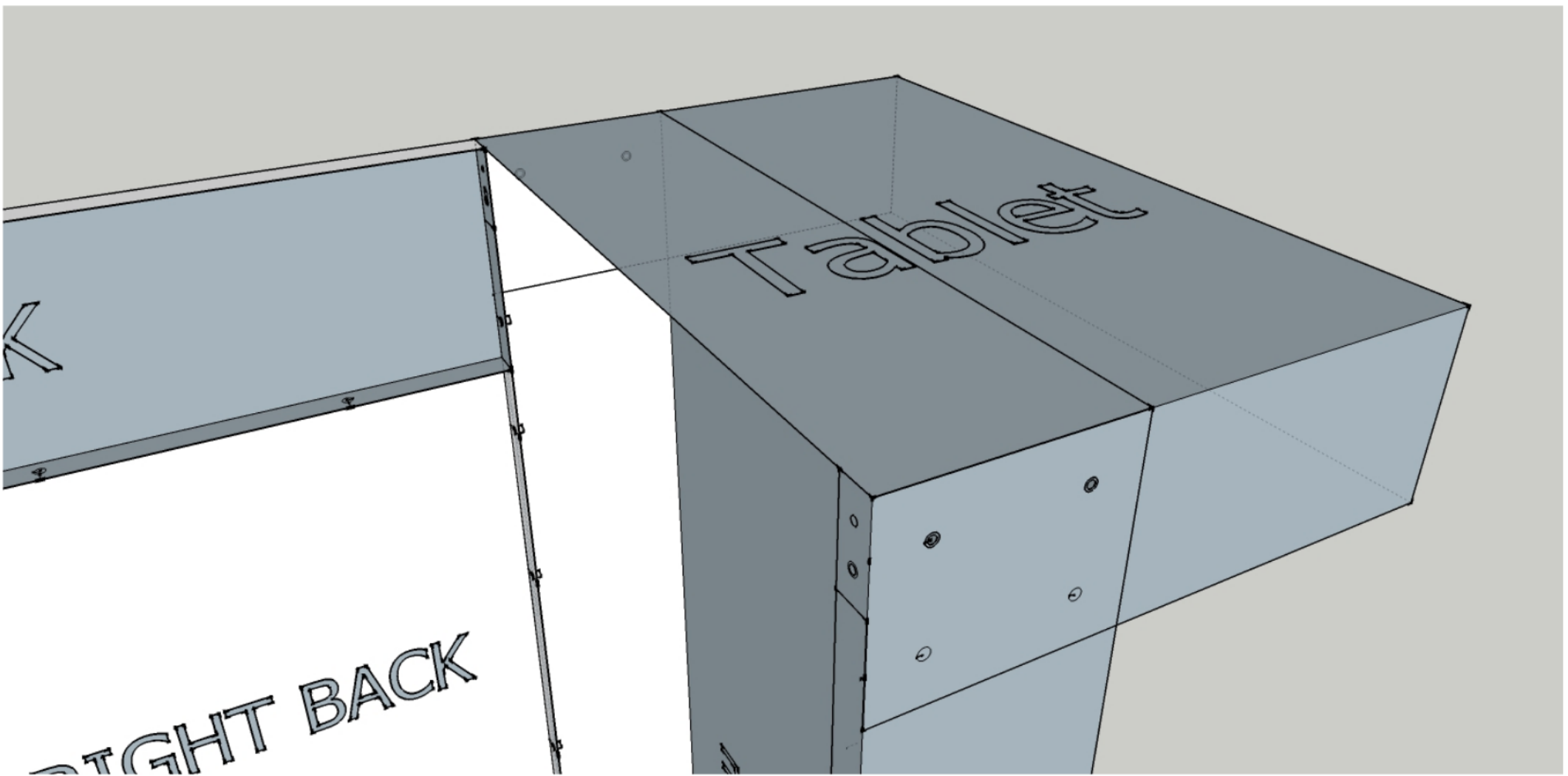

9 FRONT FACE :Add the left door, the right door them front lintel.

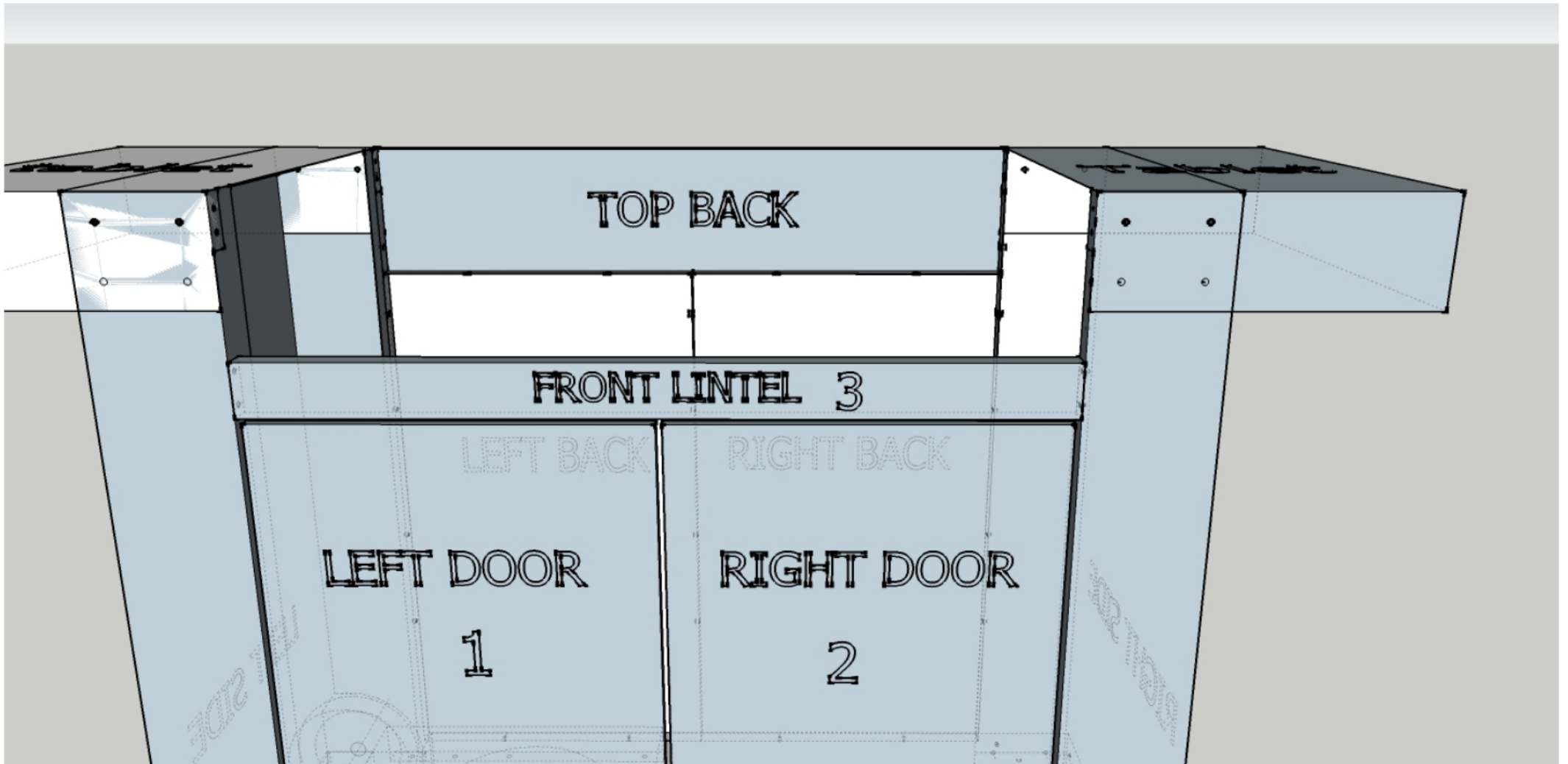

9-1 Put axis in down shelf and lintel holes

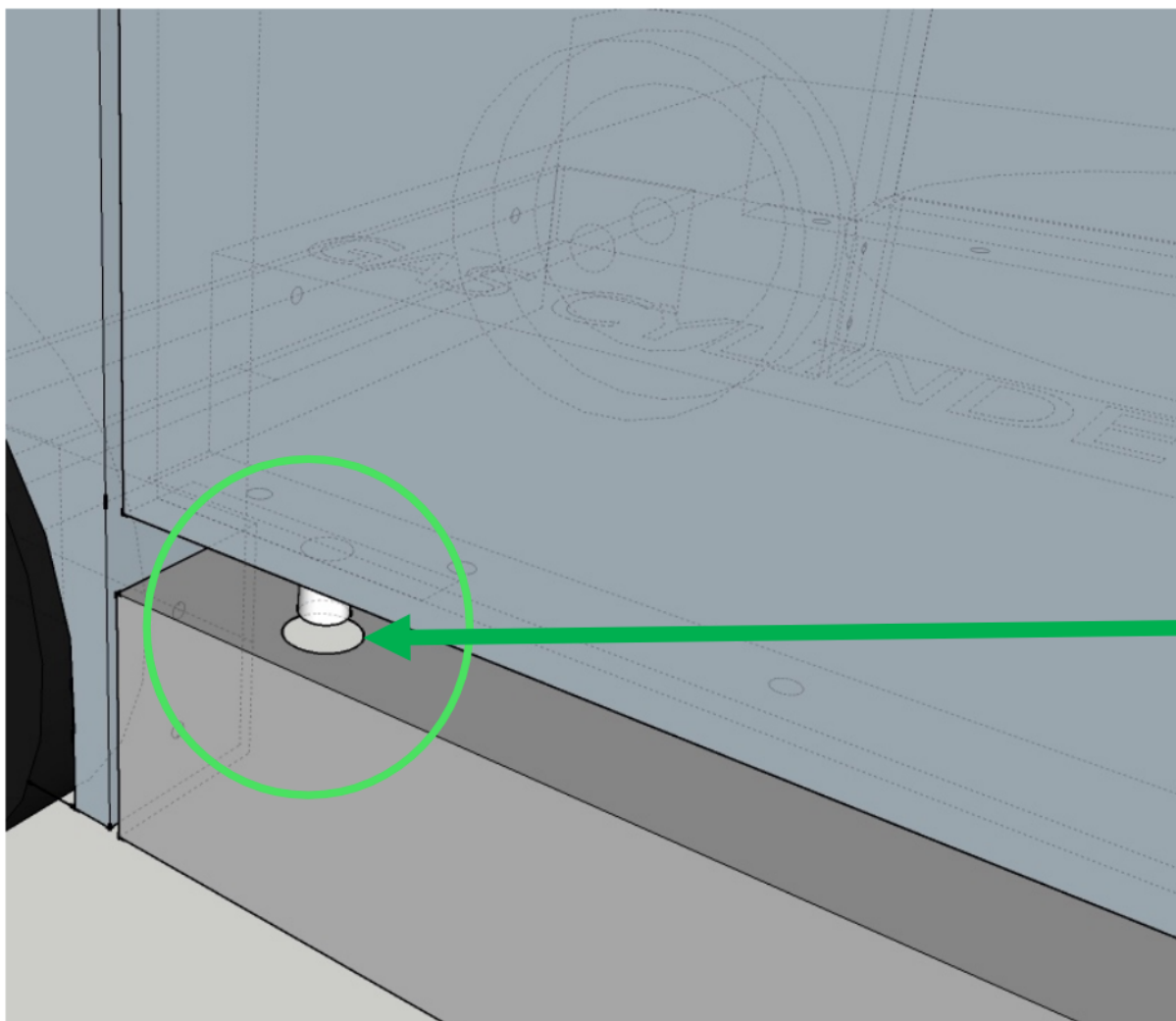

ADD AN 5 mm diameter washer

9-2 Fix the front lintel with the 2 top M4 screws

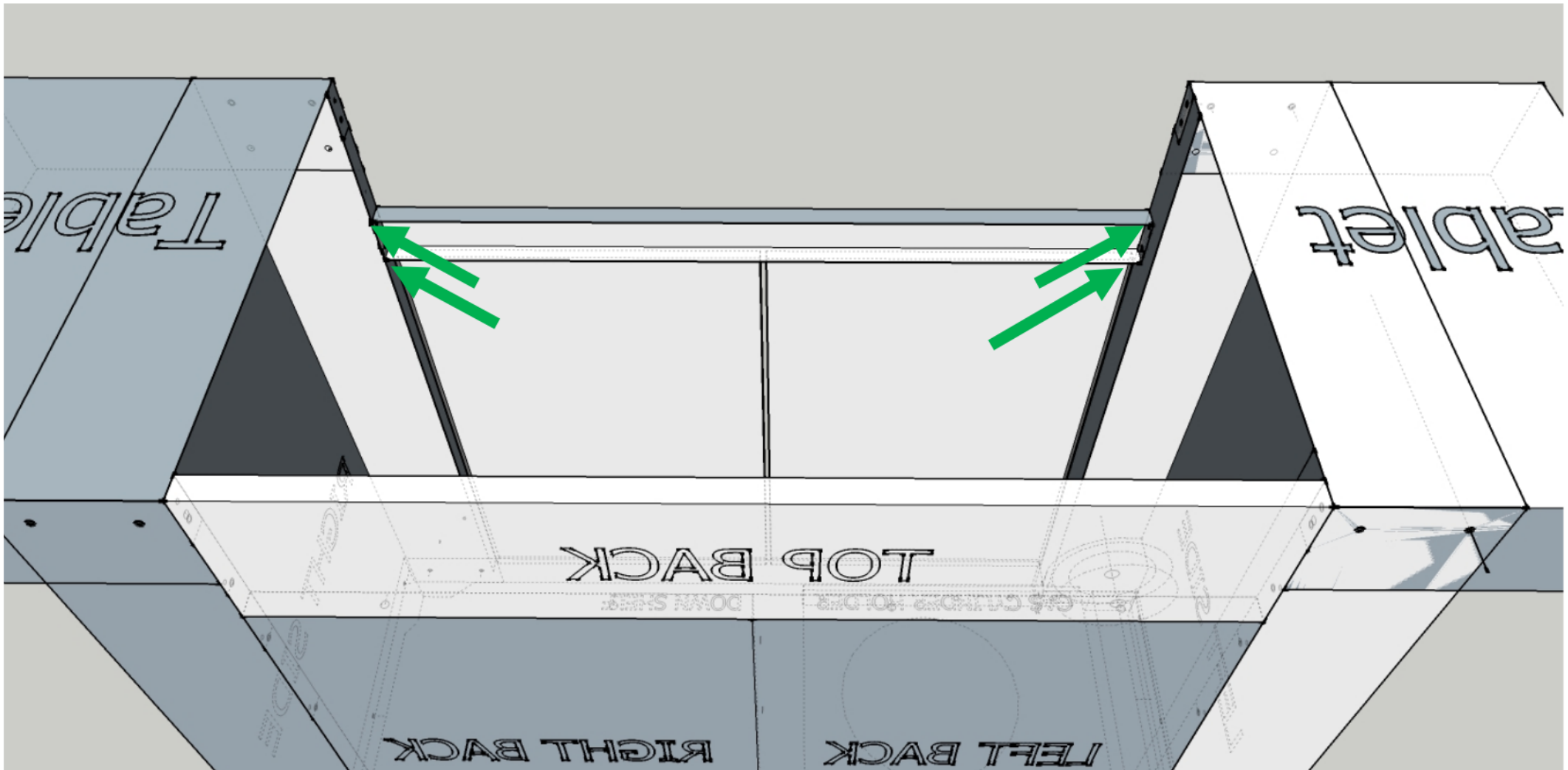

10 FIRE WALL: Fix the fire wall with the 2 M4 nuts

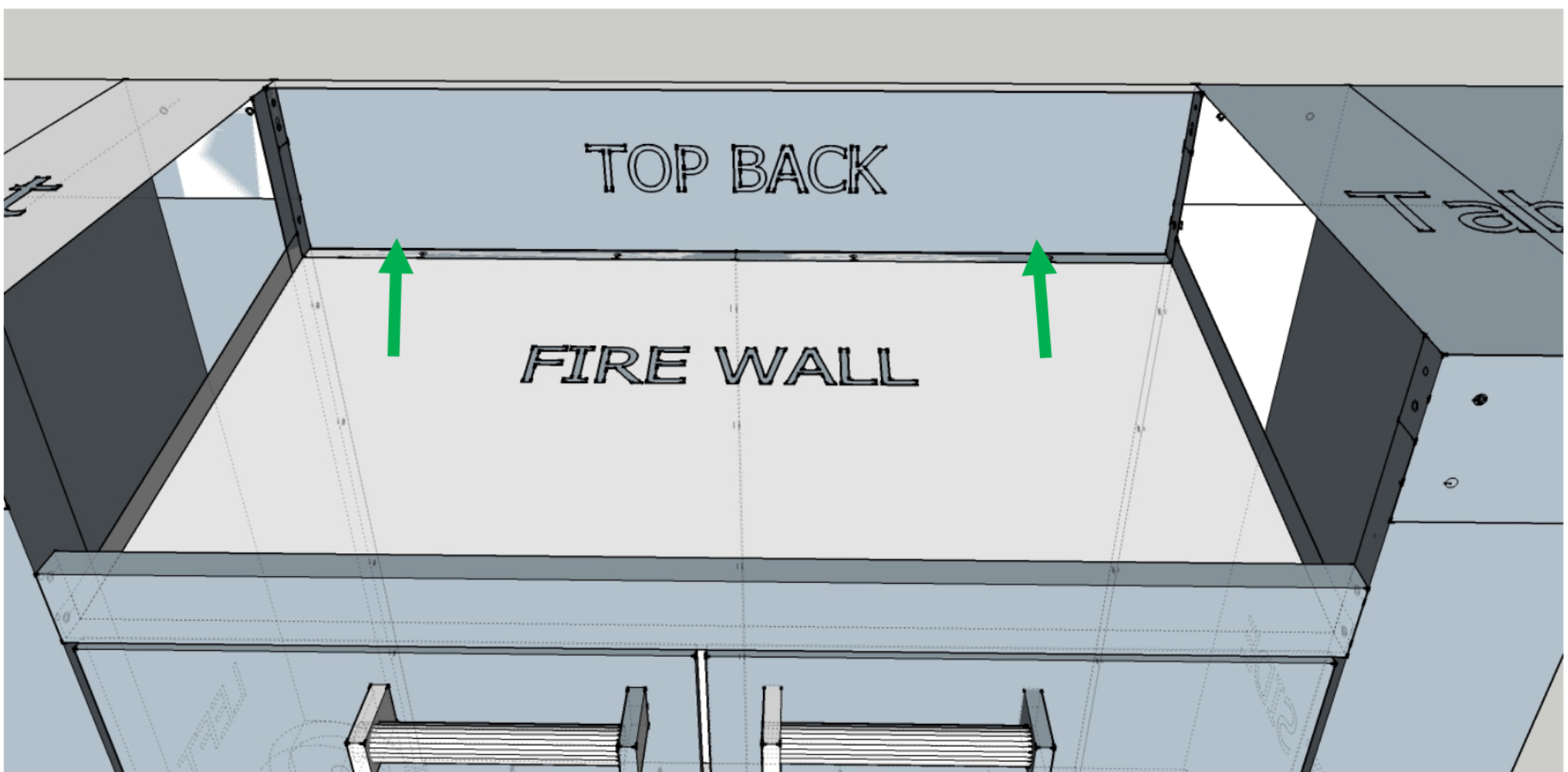

11 HANDLES AND MAGNET BRACKET: fix the handles on doors with 2x2 M4 screws, fix the Magnet Bracket with 2 M4 screw



Your LeGriddle CART is ready to use!
Please do not hesitate to contact us should you have any suggestions at contact@legriddle.com.