

App Setup Guide

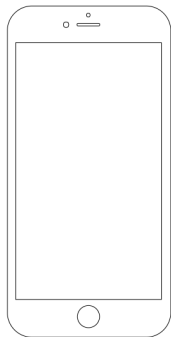

Before we get started make sure you have ready:



OR

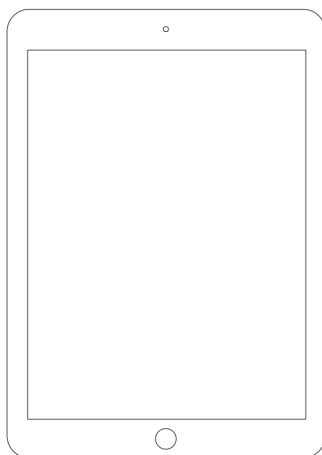

OR

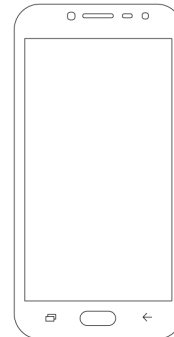

Apple iOS10 - iPhone
5/5c/6/6+/6s/6s+/7/7+/10X

iPad Mini/iPad 2nd Gen
iPad Pro and above.

Android 4.4 - Android
enabled devices including
Samsung etc.

AND



Firebug Control Module

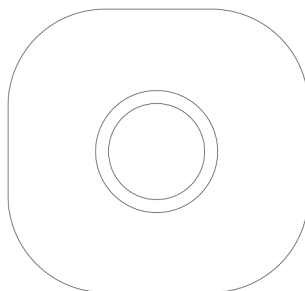

(If purchased)
WiFi-Bluetooth Module
(WiFi password from your router)

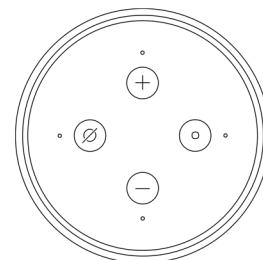

(If purchased)
Voice Control Devices
(Alexa etc.)

Creating an account.

Enter your user name or e-mail address.

Enter your password (must be one word, 6 characters long).

Enter your e-mail address. Press **Sign-up**.

You will receive an email once your registration process is complete.

Please Note: Email confirmations can sometimes arrive in your junk or spam email accounts. Please check in these accounts also.

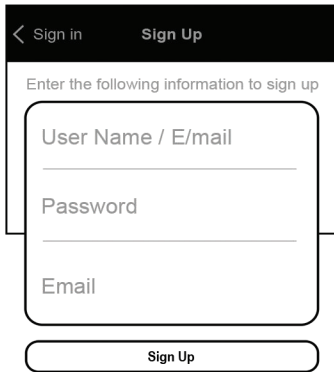

The screenshot shows a mobile app interface for signing up. At the top, there are two tabs: 'Sign in' and 'Sign Up'. Below the tabs, a header reads 'Enter the following information to sign up'. The form contains three input fields: 'User Name / E/mail', 'Password', and 'Email'. At the bottom of the form is a 'Sign Up' button.

Creating a Zone

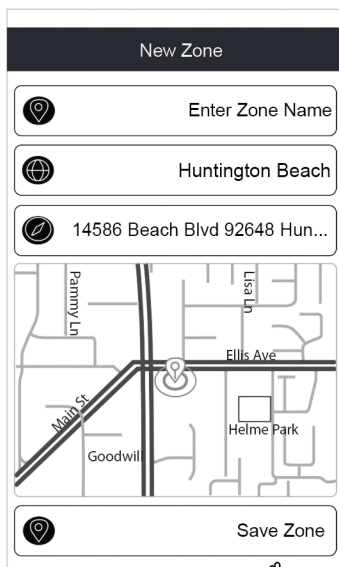

The screenshot shows a mobile app interface for creating a new zone. The title is 'New Zone'. There are three input fields: 'Enter Zone Name', 'Huntington Beach', and '14586 Beach Blvd 92648 Hun...'. Below the input fields is a map showing the location. At the bottom of the form is a 'Save Zone' button.

After creating an account, your next step is to create a Zone. A zone is an area or location where your Firebug is located based on the GPS in your phone or tablet.

Check the address shown on the screen for accuracy. Edit if necessary.

You will need to enter a name or ID for your zone. For example, if you have a fireplace located at your house, you could name your zone "Home".

Enter your zone name and then press **Save Zone**.

You can enter as many zones as you like.

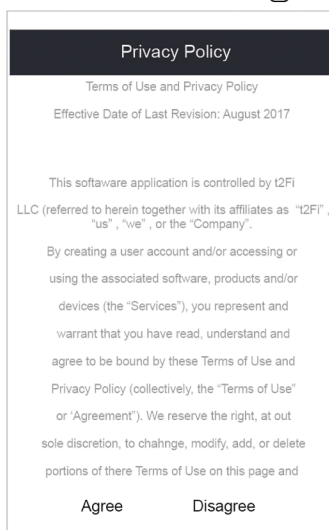

The screenshot shows a mobile app interface for the Privacy Policy. The title is 'Privacy Policy'. Below the title, it says 'Terms of Use and Privacy Policy' and 'Effective Date of Last Revision: August 2017'. The main text reads: 'This software application is controlled by t2FI LLC (referred to herein together with its affiliates as "t2FI", "us", "we", or the "Company"). By creating a user account and/or accessing or using the associated software, products and/or devices (the "Services"), you represent and warrant that you have read, understand and agree to be bound by these Terms of Use and Privacy Policy (collectively, the "Terms of Use" or "Agreement"). We reserve the right, at our sole discretion, to change, modify, add, or delete portions of these Terms of Use on this page and'. At the bottom are two buttons: 'Agree' and 'Disagree'.

After creating a zone, you will be directed to the Privacy Policy.

Please read the Privacy Policy and select **Agree** or **Disagree**.

To continue using the app you will need to select **Agree** to the privacy policy.

If you select **Disagree**, you will be re-directed back to the Zone screen.

Creating, Editing and Deleting a Zone

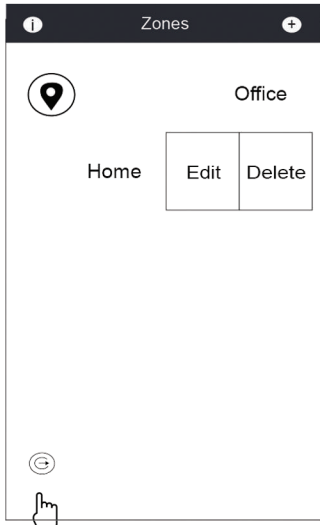

Your zones can be created here. This screen shows a zone created for the 'Office'.

You can **Edit** or **Delete** a zone by sliding your finger across a selected zone from right to left. The option box will appear, then tap on **Edit** or **Delete**.

Note: This icon is for signing out of the account of your app. You will need to sign back into the app if you sign out.

Select the zone by pressing on the zone name.

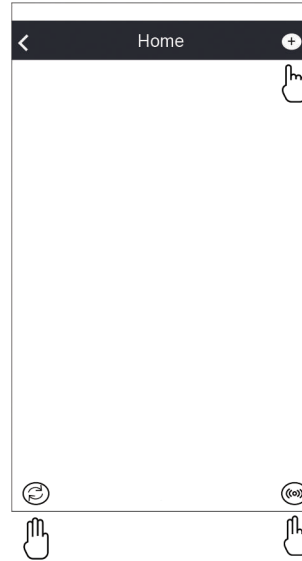

After selecting a zone, press the (+) icon in the top right corner to add a smart control.

Each device may have its own smart firebug.

You may add as many firebugs as you like.

This icon is to set up your WiFi Bluetooth Hub (if purchased).

This icon is to refresh your devices.

Adding the Firebug

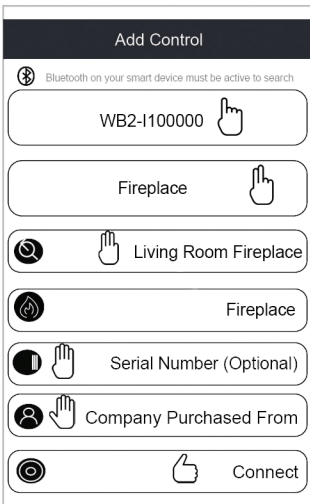

In the 1st tile, the app is now scanning for your smart control devices. Scroll until you locate your bluetooth serial number.

In the 2nd tile, scroll and select the type of firebug.

In the 3rd tile, enter a name or number for your firebug.

In the 5th tile, input your firebug serial number (optional).

In the 6th tile, enter the company name you purchased from (Optional).

In the bottom tile, press **Connect** to enter.

You have successfully entered a smart control.

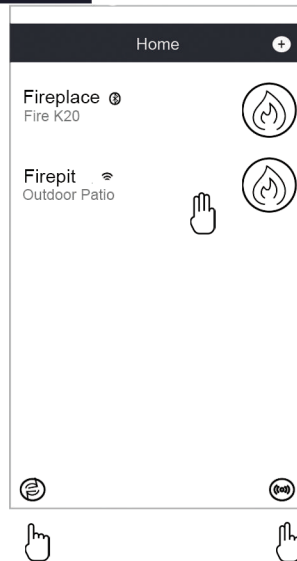

This screen shows two smart controls have been entered. You can add as many controls as you like by simply pressing the (+) again. You can view the name and the type of each Firebug.

You can delete each control by sliding to the left and pressing "Delete".

Notice the Bluetooth symbol next to one control, indicating they are in Bluetooth mode.

Notice the other control has a WiFi symbol next to it, indicating the control is in WiFi mode due to being out of range for Bluetooth.

The "Refresh" button at the bottom left corner will allow you to re-scan whenever you want.

Note the WiFi button at the bottom right corner.

Select the Firebug you want to control and press on it.

Operating the Firebug

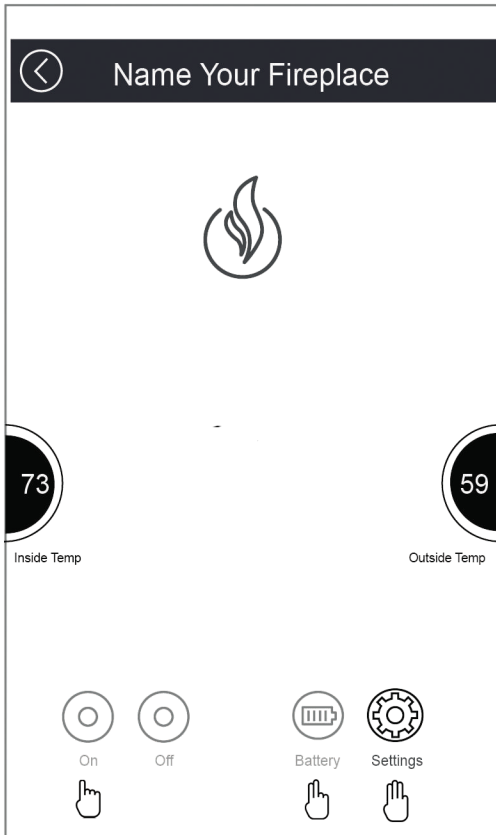

Once you open the control, you will be able to operate the Firebug from your smart device.

Press the **ON** button to start your fire.. Press the **OFF** button to turn off your fire..

This screen also displays the "Inside" and "Outside" temperatures.

The inside temperature is based on the location of the remote control. Outside temperatures are monitored through the weather channel.

Note the battery level indicator button. This monitors your battery in the module. Tap to check battery level.

Note the Settings button at the lower right corner. See below for details.

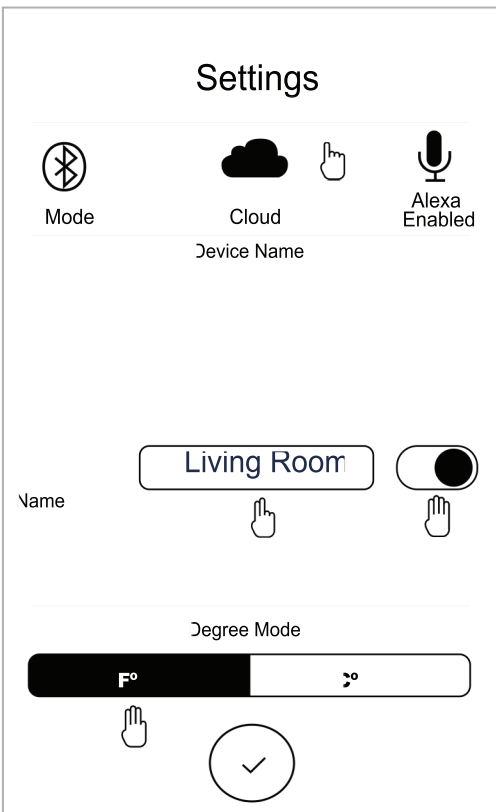

To access the remote control and the WiFi Hub ID# (if purchased), tap on the cloud icon.

To change the name of the Firebug, tap on the name tile.

You can select Fahrenheit or Celsius to be displayed.

To allow the Firebug to work with Alexa, tap on the button next to the control name. The button will change to blue color when activated.

To exit the settings screen, tap on the check mark at the bottom of the screen

Installing a Firebug



Lets get started by installing the Firebug:

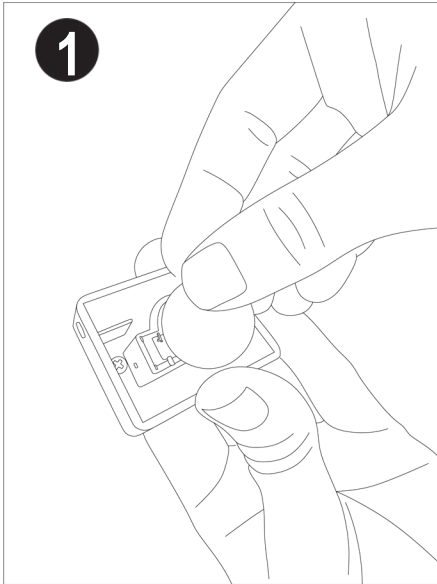

1
Insert the battery into the Firebug. To open the lid, you will need a flat head screwdriver to pop it open.

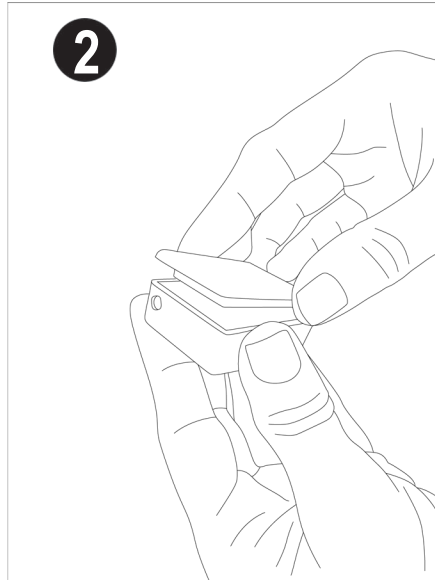

2
Close the lid.

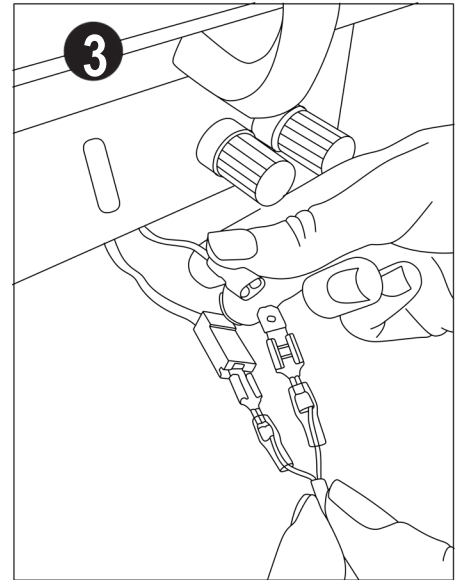

3
Connect the spade connector cable to the fireplace.



4
Connect the DC jack end of the cable to the Firebug.

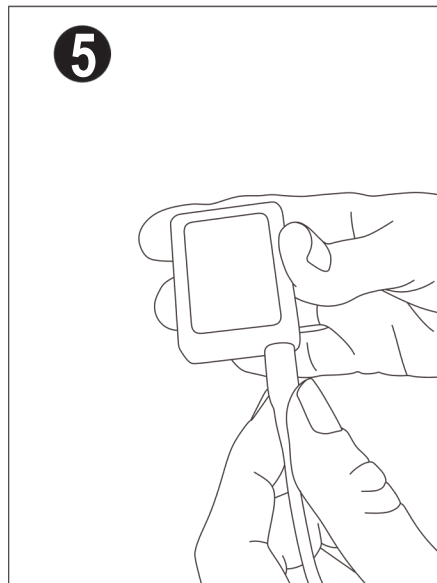

5
Place the Firebug at the location that is not affected by heat.

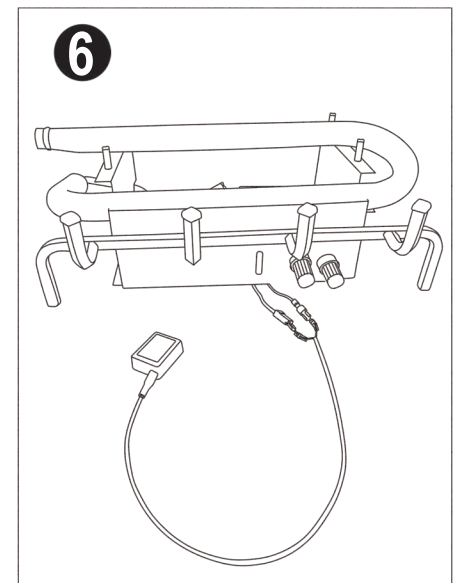

6
Your all set!

Installing a WiFi - Bluetooth Hub

If purchased



Lets get started by installing the Hub:

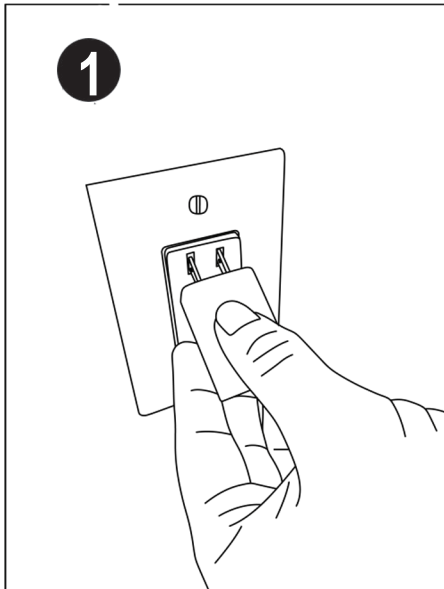

Plug USB power supply into wall outlet

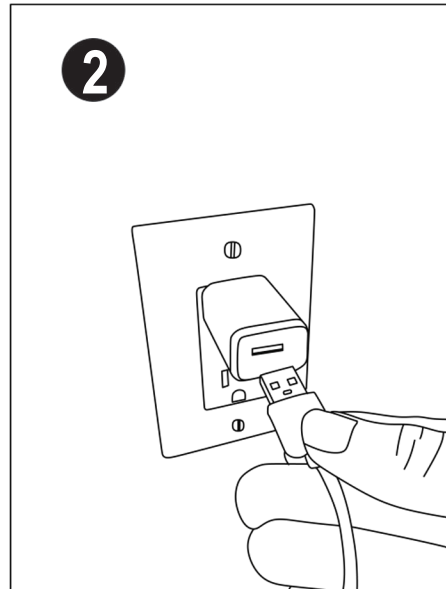

Plug USB cable into USB power supply



Plug USB cable into the hub

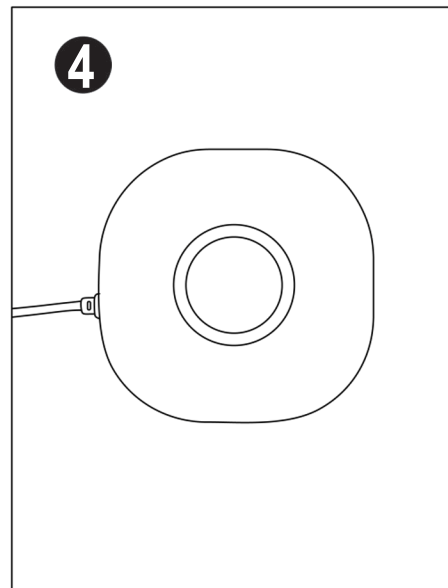

The hub status indicator will flash red, ready for set up.

Connecting the WiFi - Bluetooth Hub

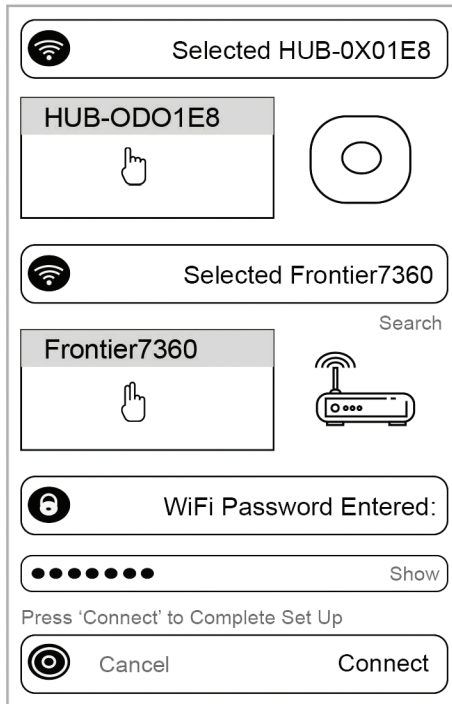

- 1. Select and tap on your WiFi hub serial number in the list, it will highlight gray. In this example, it is HUB-ODO1E8.
- 2. Tap on your WiFi network, it will highlight gray. If your network name does not appear, press the search button to scan again (the hub only connects to 2.4ghz networks only).
- 3. Enter your WiFi password. Press **Show** to view your password.
- 4. Press **Connect** to complete set up.

Note: The WiFi hub will take 2-3 minutes for configuration and connect to your WiFi router for the initial set up.

The hub is ready to go, when you see the ring indicator is solid blue.

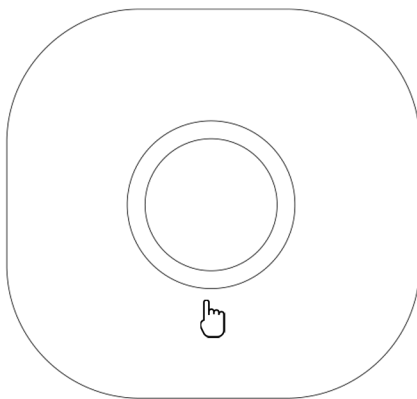

- 1. **Power On** - The indicator ring will highlight **RED** when the Hub is receiving power with **No** WiFi service.
- 2. **WiFi Service** - The indicator ring will highlight **PURPLE** when the connection to the internet is down or trying to connect to the internet service.
- 3. **Connected** - The indicator ring is **BLUE** when the Hub is fully connected and ready to go.
- 4. **Command** - The indicator ring will pulse **BLUE** when the Hub has received a command.

The bluetooth remote control must be within 20ft of the WiFi Hub in order for a WiFi command to be established.

A WiFi command will take up to 6 seconds to complete in some cases depending on WiFi conditions.

Connecting the Alexa Skill



Open your Alexa app on your smart device or computer.

Tap on the **Skills** in the Alexa app.

Search for the app skill in the search field in the Alexa app (The app skill is the name of your app that controls your bluetooth remote control).

Select the skill that is associated with your app.

Select **Enable**, then enter the Username and Password that you entered to create an account in your app that is used for your bluetooth remote control.

Once successfully enabling the skill, a pop up screen will ask you to discover devices. Alternatively you can ask Alexa to Discover Devices.

