



THE OUTDOOR
GREATROOM
COMPANY

Bronson Fire Pit

Installation Instructions for Bronson Pit Table
BRON52-K





IMPORTANT



Please consult your Crystal Fire® Plus instruction manual for detailed instructions and important information related to the burner installation including: lighting and operating instructions, safety information, and proper tightening of connections with two wrenches.

DO NOT ATTEMPT TO INSTALL CRYSTAL FIRE® PLUS BURNER WITHOUT CONSULTING THE CRYSTAL FIRE® PLUS OWNER'S MANUAL.

CONTENTS

1. About Your Fire Table	2
a. Required Tools	
b. Included With Your Fire Pit	
2. Setting Up Your Burner	3
3. Assembly Instructions	4
a. Unpacking	
b. 1-3 Brick Row Assembly	
c. CF-SPARKER Assembly	
d. Control Panel Assembly	
e. Thermocouple Installation	
f. Electrode Installation	
4. Finishing Fire Pit.....	9
a. Control Panel Attachment	
b. Final Layer Assembly	
c. Fire Media Installation	
5. Operating Instructions	11
6. Warnings	12
7. Warrenties	13

1. ABOUT YOUR FIRE TABLE

A. REQUIRED TOOLS

- **Utility Knife**
To cut and remove packaging
- **2 Open Ended Wrenches**
To secure gas connections
- **Phillips Screw Driver** (*Do not use a drill to assemble*)
For assembly
- **One AAA Battery** (*Not Included*)
Required for electric spark igniter installation

B. INCLUDED WITH FIRE PIT KIT

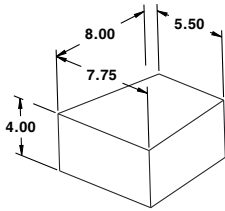

7.75" X 5.50" X 4.00" Brick
(84)



Capstone (Optional)
(4)

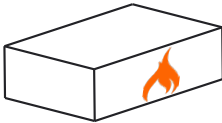

BI28 Burner and Accessories
(1)

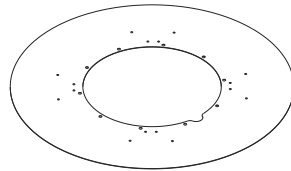

42 Inch Round Burner Plate (BP42RD)
(1)

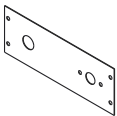

Control Panel (10259)
(1)

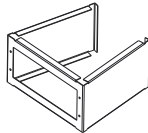

Control Panel Block (10393)
(1)

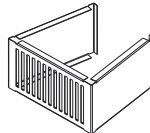

Vent Block (10394)
(2)



34" Whistle Free
Stainless Steel
Flex Line (10367)
(1)

Refer to Crystal Fire® Plus manual for items included with Crystal Fire® Plus burners



2. SETTING UP YOUR BURNER

ATTENTION

Read and understand your Crystal Fire® Plus owner's manual before beginning burner hookups or using the device.

DO NOT USE TEFLON TAPE OR PIPE DOPE ON FLARE FITTINGS.

IMPORTANT

Please consult your Crystal Fire® Plus instruction manual for detailed instructions and important information related to the burner installation including: lighting and operating instructions, safety information, and proper tightening of connections with two wrenches.

DO NOT ATTEMPT TO INSTALL CRYSTAL FIRE® PLUS BURNER WITHOUT FIRST CONSULTING THE CRYSTAL FIRE® PLUS OWNER'S MANUAL.

A. GAS CONNECTIONS

- **See Crystal Fire® Plus instructions for burner installation.**
- All gas connections were completed at the factory.
- Check all connections for leaks. If needed, tighten connection with 2 wrenches and re-check for leaks.
- For hard piped installations. Connect the gas supply line (*not included*) to the 3/8" male flare fitting on the valve. **USE TWO WRENCHES TO ENSURE A GAS TIGHT CONNECTION.**

3. ASSEMBLY INSTRUCTIONS

WARNING

Exposed edges may be rough, use leather gloves when removing packaging and handling the bricks.

A. UNPACKING

Do not discard any packaging until assembly is complete and unit is tested. Keep all included manuals in a safe place for future reference. Keep bricks stacked until ready to be placed.

B. 1-3 BRICK ROWS ASSEMBLY

1. Once desired location for fire pit has been determined, start with placing first layer of bricks. Follow the diagram shown below for layout pattern.

LAYER 1

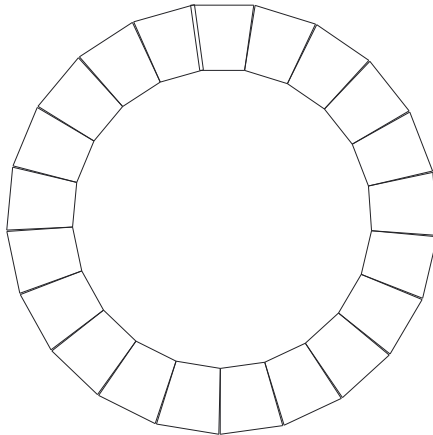

FRONT



2. Continue on to second row of bricks. This layer will contain the 2 vent blocks (*included in kit*) and the control panel block (*included in kit*). Follow diagram shown below for layout pattern.

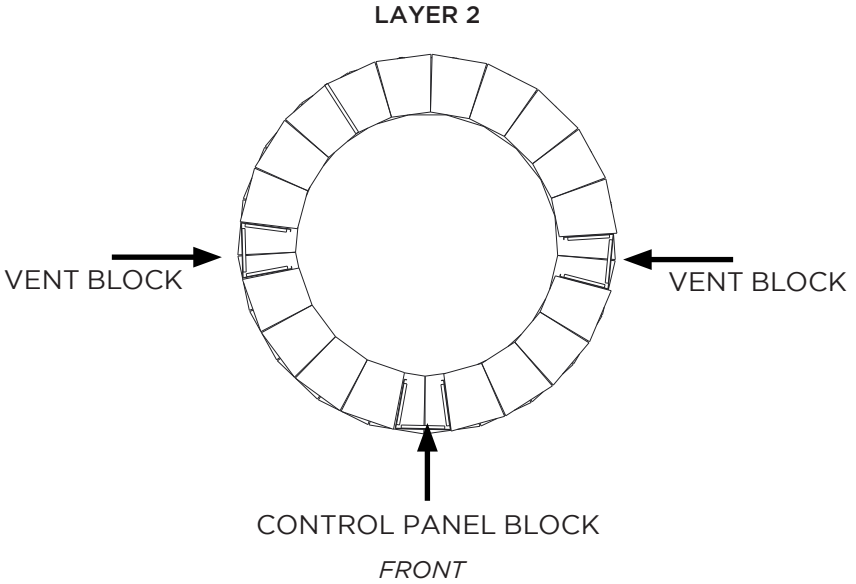

3. Continue on to third row of bricks. Follow diagram shown below for layout pattern.

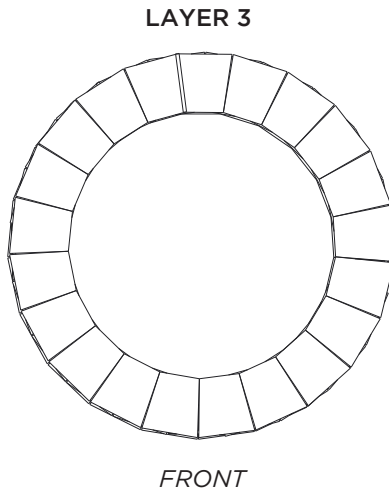

4. Unpack burner. Before installing the burner into the burner plate, remove the 24 inch flex line between burner oriface and valve and connect included 34 inch flex line. Use 2 wrenches to tighten and perform leak test. Set burner into burner plate.

Position burner plate in center of fire pit and then pull plate so that end is slightly off edge. Leave a gap between control panel block and burner plate so that hands are able to fit and make connections outlined in future steps.

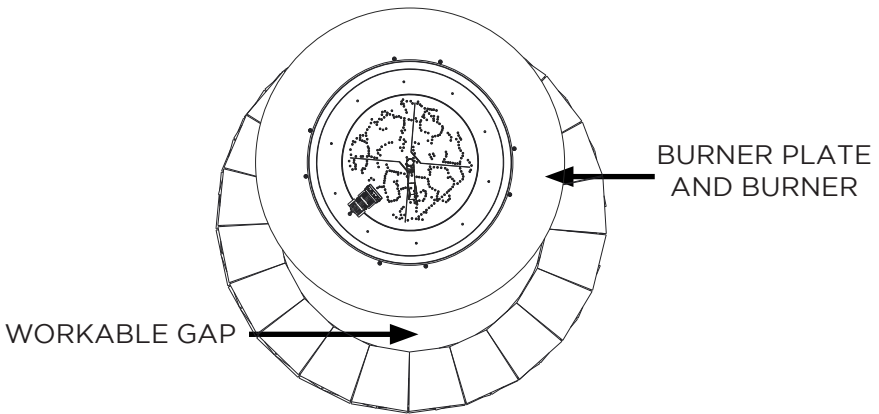



C. CF-SPARKER ASSEMBLY

- Locate CF-SPARKER inside of Crystal Fire® Plus burner box.
- Remove CF-SPARKER cap and hex nut. Insert AAA battery (*not included*) with + end out.
- Install CF-SPARKER into control panel as shown below. CF-SPARKER must be installed **BEFORE** control valve.
- Press in CF-SPARKER button to test your sparker.

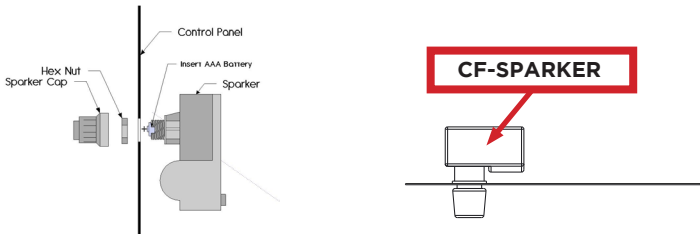

D. CONTROL PANEL ASSEMBLY

- Pull the VCSV valve through the back and then front opening of the control panel block.
- Connect a whistle free flexible gas supply line to the inlet of valve using a 1/2" flare nut.
- Attach burner valve to control panel with provided screws. Ensure CF-SPARKER is installed before this step.

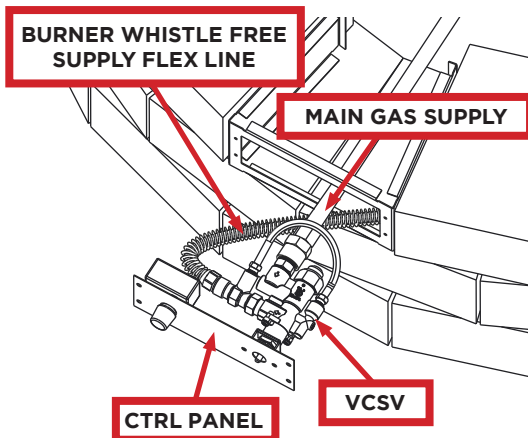

E. THERMOCOUPLE INSTALLATION

- Refer to Crystal Fire® Plus instruction manual for detailed attachment of thermocouple.
- Attach thermocouple to burner valve as shown below.

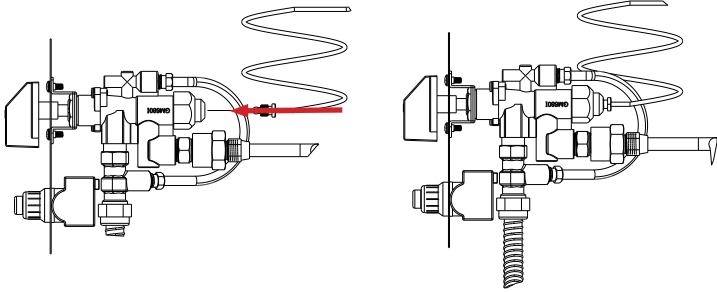

C. ELECTRODE INSTALLATION

- Plug both BLACK wires hanging from the burner into the back of the CF-SPARKER. If an orange wire is present, DO NOT USE IT. The orange wire is for Direct Spark Ignition system only.
- Test system by pushing the button on the igniter. Consult the troubleshooting section of the Crystal Fire® Plus owner's manual if the spark is weak, intermittent or not present.

**Flexline removed in image for visibility.*

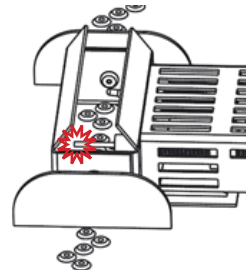
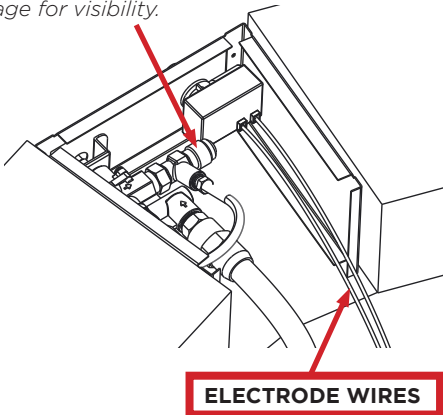



4. FINISHING FIRE PIT

A. CONTROL PANEL ATTACHMENT

Push control panel back into control panel block, making sure all connections are tucked in and not kinked. Using the 4X provided metal screws, attach the control panel to the control panel block. Finalize by pressing the control panel knob onto the stem of the VCSV valve.

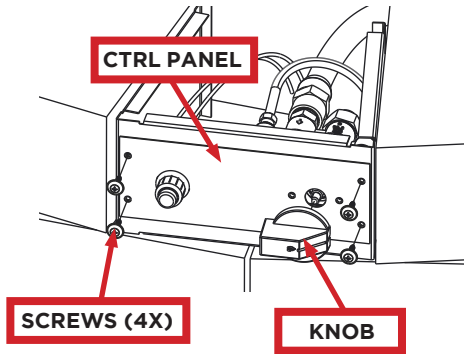

B. FINAL BRICK LAYER ASSEMBLY

Move burner and burner plate back towards center of fire pit. Place bricks as final layer. Follow diagram shown below for layout pattern.

LAYER 4

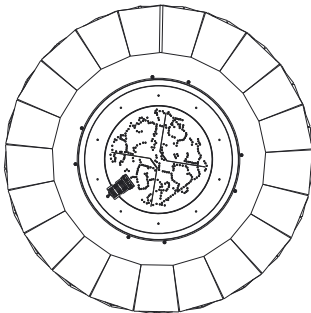

FRONT

LAYER 4 (optional capstone)

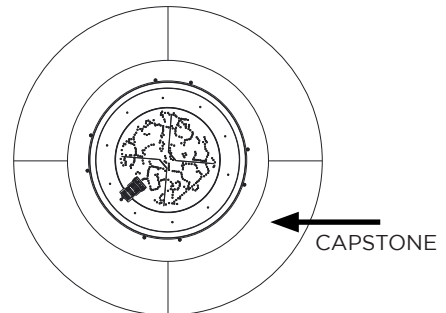

FRONT

OPTIONAL CAPSTONE SETUP: The BRON52-K has an optional capstone. The capstone can be placed on top of layer 3 (replacing the brick of layer 4) or on top of layer 4. When using the optional capstone ensure that the burner plate is one layer below the capstone.

C. FIRE MEDIA INSTALLATION

- Scatter all included glass beads, lava rock, or other approved fire media evenly across entire burner surface.

WARNING

DO NOT OPERATE CRYSTAL FIRE® PLUS BURNER WITHOUT INCLUDED GLASS BEADS OR OTHER APPROVED FIRE MEDIA.

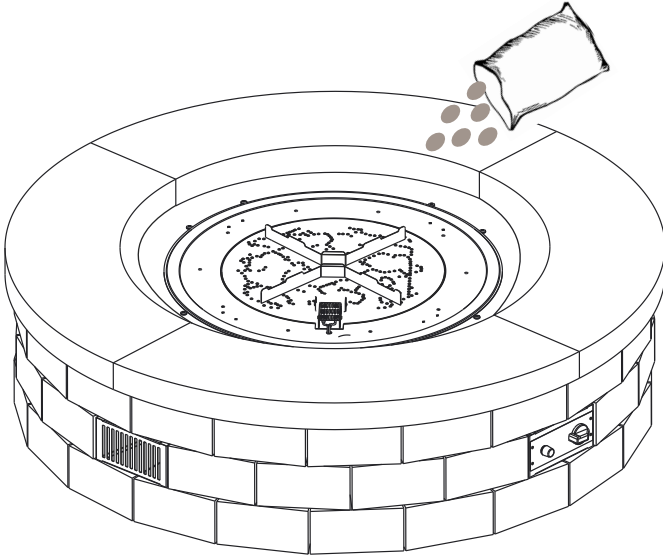



5. OPERATING INSTRUCTIONS

IMPORTANT

Before operating your BRON52, ensure all gas connections are properly tightened and thoroughly leak checked. Refer to the Crystal Fire® Plus manual for information on proper leak checking and other critical safety information.

WARNING

FIRE OR EXPLOSION HAZARD

If you do not follow these instructions exactly, a fire or explosion may result causing property damage, personal injury, or loss of life.

Verify control valve is in OFF position. If operating on a self-contained propane cylinder, ensure cylinder valve is CLOSED. If operating on a hard-piped system, ensure main gas supply shut-off valve and all other valves in gas system are OPEN.

If operating on a self-contained propane cylinder, slowly open cylinder valve.

Press and hold sparker button. Verify an audible and visible spark is present within the ignition wind guard.

Gently press and turn control knob to LOW/IGNITION position. Fully depress control knob and hold for 3-5 seconds. Burner should ignite and continue to operate when control knob is released.

If burner does not light or remain lit after 20 seconds of attempting ignition, turn control valve to OFF position and wait 5 minutes to allow gas to dissipate before attempting ignition again. **DO NOT ATTEMPT TO LIGHT BURNER IF YOU SMELL GAS.**

With burner lit and operating, the flame height can be adjusted between LOW and HIGH at any time.

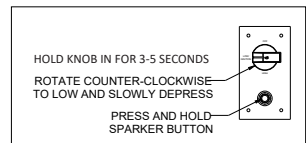
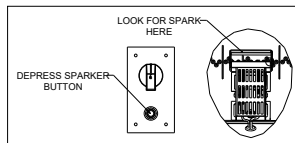
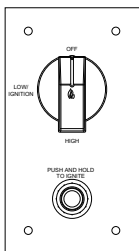

6. WARNINGS

IMPORTANT

Please consult your Crystal Fire® Plus instruction manual for detailed instructions and important information related to the burner installation including: lighting and operating instructions, safety information, and proper tightening of connections with two wrenches.

DO NOT ATTEMPT TO INSTALL CRYSTAL FIRE® PLUS BURNER WITHOUT FIRST CONSULTING THE CRYSTAL FIRE® PLUS OWNER'S MANUAL.

WARNING

After consulting the manual and following instructions, remember: before operating, all gas connections must be fully checked for leaks.



WARNING: This product can expose you to chemicals including Carbon Monoxide and Benzene which are known to the State of California to cause cancer or birth defects or reproductive harm. For more information, visit www.P65Warnings.ca.gov



7. WARRANTIES

PRODUCT CATEGORY	WARRANTY INFORMATION
GAS FIRE PIT TABLES/CRYSTAL FIRE® BURNER	<p>Limited lifetime warranty on all stainless steel burners installed in a residential setting, and 5 years on all stainless steel burners installed in a commercial setting.</p> <p>One year warranty on ignition & electronics</p> <p>One year finish warranty</p> <p>Three year structural warranty on all fire pit bases and tops</p>

Thank you for purchasing an
Outdoor GreatRoom Company
product! This fire pit was made
with pride in the USA.



Warranty: Fire pit tables are covered under a 1 year
manufacturer's warranty.

Please visit <http://www.outdoorrooms.com/product-registration>
to register your product.

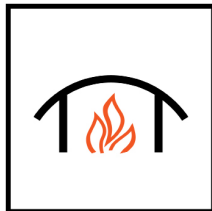

14400 Southcross Drive West • Suite 100 • Burnsville, MN 55306
Toll Free: 1-866-303-4028 • Sales@OutdoorRooms.com