

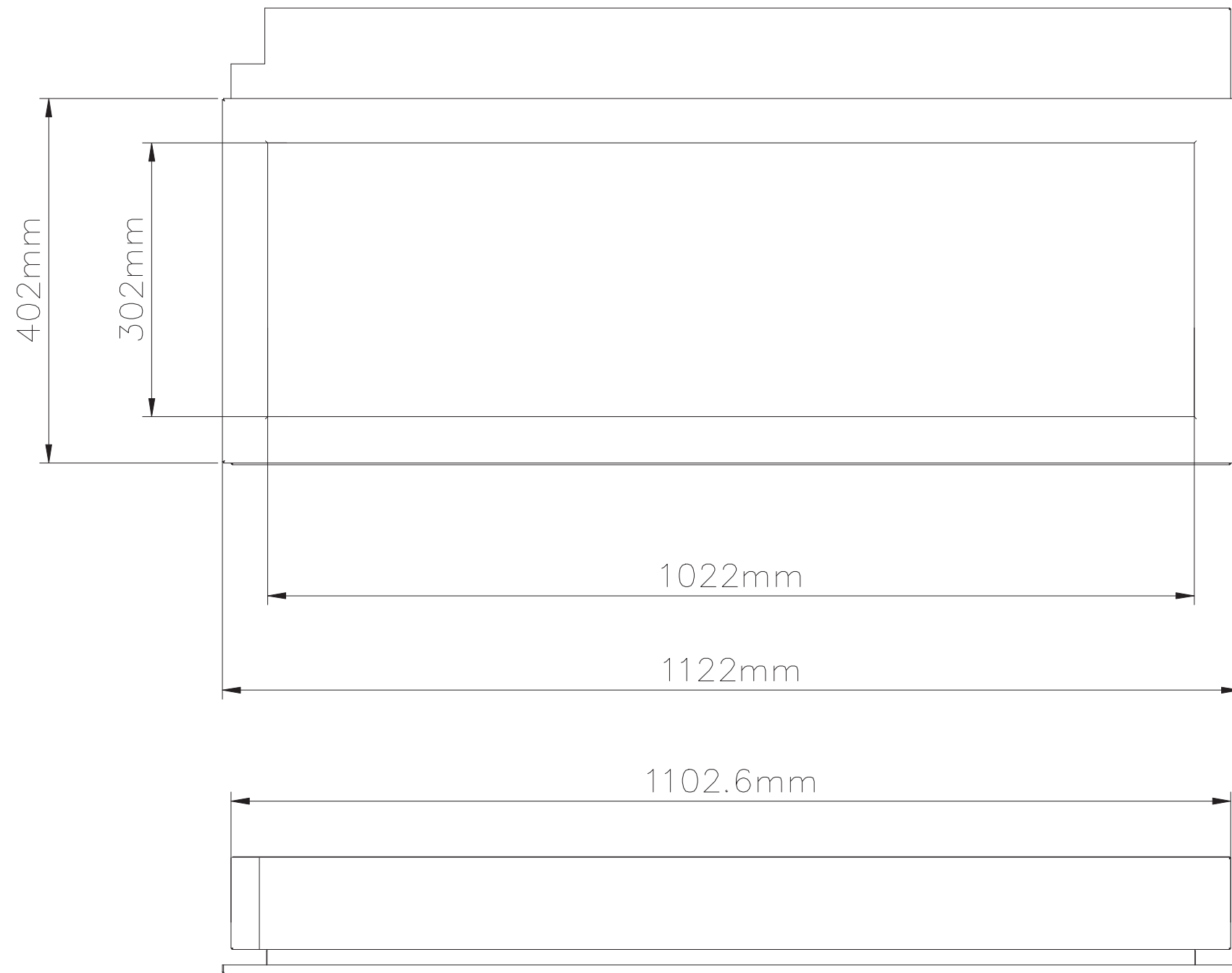

TECHNICAL SPECIFICATIONS	
VOLTAGE	120 AC 60 Hz
WATTS	1500 W Max
NO HEATER	25 W
MOTOR HEATER	19 W
APPLIANCE WIDTH	44 1/8"
APPLIANCE HEIGHT	19 7/8"
APPLIANCE DEPTH	4
GROSS WEIGHT	62 lbs
PLUG LOCATION	Left side
CORD LENGTH	70 7/8"
ROUGH WALL OPENING	44" X 20 3/8" or
BTU	4800



SERIES Built-In	MODEL BI-45-XTRASLSIM		REV 1
SCALE 1" = 1'-0"	DATE: 11/16/2017	SHEET 1 OF 1	



TECHNICAL SPECIFICATIONS	
VOLTAGE	120 AC 60 Hz
WATTS	1500 W Max
NO HEATER	25 W
MOTOR HEATER	19 W
APPLIANCE WIDTH	99.5 cm
APPLIANCE HEIGHT	50.4 cm
APPLIANCE DEPTH	10.25 cm
GROSS WEIGHT	28 kgs
PLUG LOCATION	Left side
CORD LENGTH	180 cm
ROUGH WALL OPENING	111.8 cm X 52 cm
BTU	4800



SERIES Built-In	MODEL BI-45-XTRASLSIM		REV 1
SCALE 1" = 1'-0"	DATE: 11/16/2017	SHEET 1 OF 1	