



Model: 5301P

INSTALLATION AND OPERATION INSTRUCTIONS

IF YOU CANNOT READ OR UNDERSTAND THESE INSTALLATION INSTRUCTIONS DO NOT ATTEMPT TO INSTALL OR OPERATE

NOTE: This product is designed for use with an attended hearth appliance or fire feature. Adults must be present when the Control System is operating. DO NOT program or thermostatically set this Control to operate a hearth appliance or fire feature when Adults are not physically present. Furthermore, DO NOT leave the hearth appliance or fire feature burning unattended; it may cause damage or serious injury. If an Adult is going to be away from the hearth appliance or fire feature for any length of time, then the handheld/wall mount, receiver/control module and application should be in the "OFF" position.

INTRODUCTION

This remote control system was developed to provide a safe, reliable, and user-friendly remote control system for gas heating appliances. The system can be operated thermostatically, manually or with the built-in factory program inside the transmitter. The built-in program has two segments, a weekdays and a weekend segment. The factory presets are time periods for each day. SEE PROGRAM SEQUENCE BELOW. Custom programming may be achieved after the initial setup has been performed.

This system operates on radio frequencies (RF) within a 20-foot range using non-directional signals. The system operates one of 1,048,576 security codes that are programmed into the transmitter at the factory; the remote receiver's code must be matched to that of the transmitter prior to initial use.

Built-in Factory Programs			
Weekdays - Mon. Tues. Wed. Thurs. Fri.			
Program 1 (P1)	5:00AM	MORN → 9:00AM 72°	Program 2 (P2)
			4:00PM
			DAY → 10:00PM 72°
Weekends - Sat. Sun.			
Program 1 (P1)	6:00AM	MORN → 10:00AM 72°	Program 2 (P2)
			5:00PM
			DAY → 10:00PM 72°

Table 1 Factory program.

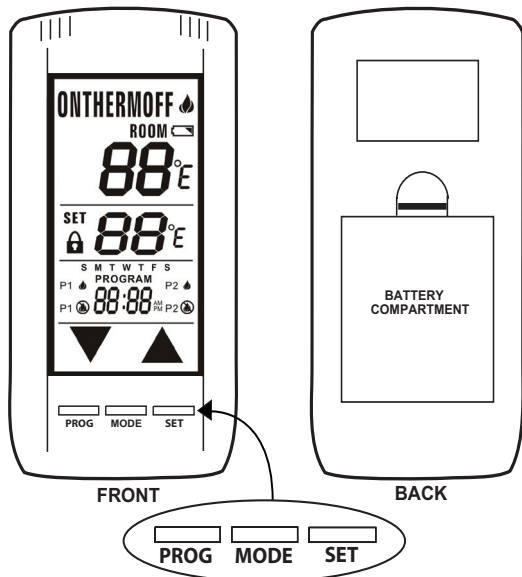

TRANSMITTER

The transmitter operates on (4) AAA 1.5V batteries that are included. Install the batteries supplied with the unit into the battery compartment. It is recommended that ALKALINE batteries always be used for this product. **Be sure the batteries are installed with the (+) and (-) ends facing the correct direction.**

When you start up the remote, if a low battery signal appears or if the LCD screen does not illuminate when you touch it, check battery position and if the batteries are fully charged.

Fig. 1 Transmitter.

Review **COMMUNICATION SAFETY** under **TRANSMITTER** section and **THERMO SAFETY** under **REMOTE RECEIVER** section. These signal and temperature safety features shut down the fireplace system when a potentially unsafe condition exists.

KEY AND TOUCHSCREEN SETTINGS

1. **MODE** - Switches the appliance On/Thermo/Off.
2. **PROGRAM** - Turns ON and OFF the program function.
3. **SET** - Used in different functions to confirm settings.
4. **UP and DOWN** - Used to change the time, set temp, and programming functions.

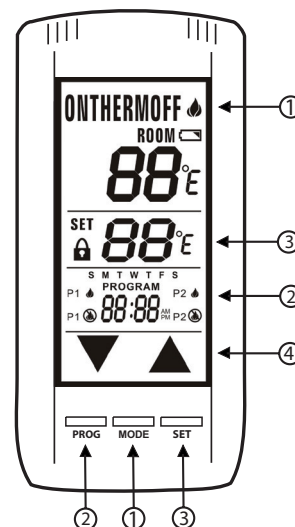

Fig. 2 Button settings.

LCD - LIQUID COLOR DISPLAY

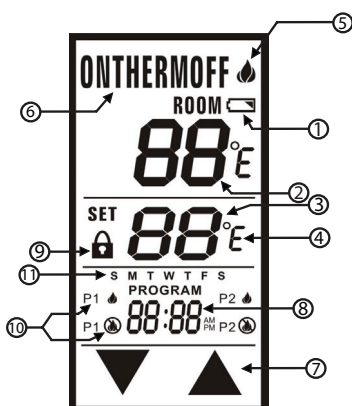

Fig. 3 LCD display.

1. **BATTERY ICON** - Battery power is low. Replace Batteries in 2 - 4 weeks.
2. **ROOM** - Indicates CURRENT room temperature.
3. **SET** - Indicates desired SET room temperature for THERMO operation.
4. **FAHRENHEIT/CELSIUS** - Indicates degrees Fahrenheit or Celsius.
5. **FLAME** - Indicates burner/valve in operation.
6. **MODE** - Indicates operation mode of system.
7. **UP and DOWN** - These are used to adjust the Time, Set temperature, and Program functions.
8. **TIME and PROGRAM TIME** - Indicates current time or program time setting when editing program settings.
9. **LOCK ICON** - Disables the transmitter when lock is visible on the LCD screen.
10. **PROGRAM ON/OFF** - Indicates when Program 1 (P1) is on or off, and indicates when Program 2 (P2) is on or off.
11. **DAY of WEEK** - Indicates current day of week, or program segment when editing program settings.

BASIC TRANSMITTER FUNCTIONS AND INITIAL SETUP

NOTE: Touch anyplace on the screen and the back light will light up and stay lit for 5 seconds.

MODE FUNCTION

To select an operational mode, press the **MODE** (top) button or touch the **MODE** (top) SECTION of the touch screen.

- **ON** turns the appliance manually ON; the flame icon will appear.
- **THERMO** sets the remote to Thermostatic mode.
- **OFF** turns the appliance OFF; the flame icon will disappear.

SETTING °F / °C SCALE

The factory setting for temperature is °F. To change this setting to °C, first press and hold the **UP** touch button and the **DOWN** touch button on the transmitter at the same time. Follow this same procedure to change from °C back to °F.

NOTE: When changing between the °F and °C scales, the set temperature defaults to the lowest temperature (45 °F, or 6 °C).

SETTING THE CLOCK

- Press and hold the **SET** button, or touch the **SET** section on the touch screen, for 5 seconds. The hour section should begin to flash. (Fig. 5)
- Use the **UP** and **DOWN** touch buttons to select the hour, then press **SET**.
- The minutes will be flashing. Use the **UP** and **DOWN** touch buttons to select the minute, then press **SET**. (Fig. 6)
- The AM PM will be flashing. Use the **UP** and **DOWN** touch buttons to select one of them, then press **SET**. (Fig. 7)
- One of the days of the week will be flashing (above the clock). Select the correct day by pressing the **UP** and **DOWN** touch buttons, then press **SET**. Your time will automatically be accepted. (Fig. 8)

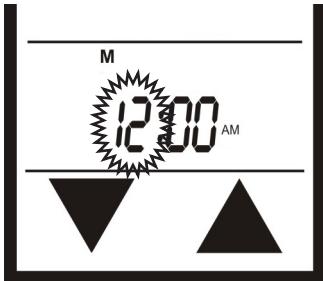

Fig. 5 Hours.

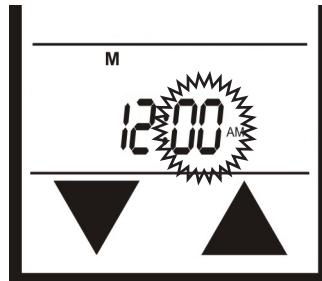

Fig. 6 Minutes.

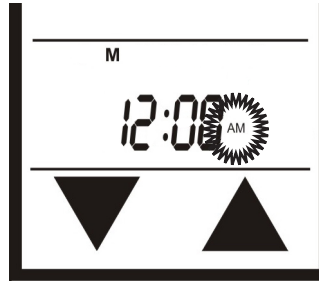

Fig. 7 AM/PM.



Fig. 8 Days of week.

THERMOSTAT FUNCTION

This remote control system can be thermostatically controlled when the transmitter is in the THERMO mode (THERMO must be displayed on the screen). To set the desired room temperature, press the **MODE** button to place the transmitter into thermo mode, then press the **UP** or **DOWN** touch buttons to select the desired room temperature. The highest set temperature is 99°F (32°C).

THERMO UPDATING FEATURE - TRANSMITTER

When in thermo mode, the transmitter reads the ROOM temperature every 2 minutes, checks the room temperature against the SET temperature then sends a signal to the receiver.

NOTE: The thermo feature operates the appliance whenever the room temperature varies a certain number of degrees from the set temperature. This variation is called the "swing" or temperature differential. This feature lets the appliance turn off and on 2° F (1° C) above or below the set temperature of the room. This is to cushion the number of times the appliance is turned ON and OFF. See Swing setting on page 6, Figure 19.

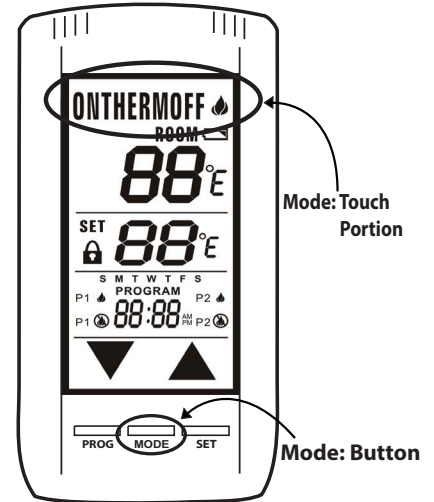

Fig. 4 Transmitter functions.

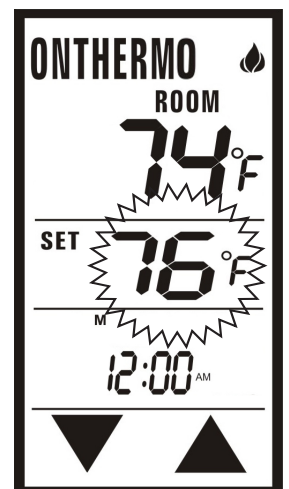

Fig. 9 Thermo mode.

PROGRAM FUNCTION

This remote has two default program segments (P1) and (P2): A weekday segment and a weekend segment. To enter program mode, push the **PROG** button or touch the **PROGRAM** (bottom) portion of the touchscreen; the word PROGRAM will appear above the display time to indicate program operation is active.

The factory presets are:

WEEKENDS	WEEKDAYS
"P1 ON" 6:00 AM at 72°F	"P1 ON" 5:00 AM at 72°F
"P1 OFF" 10:00 AM	"P1 OFF" 9:00 AM
"P2 ON" 5:00 PM at 72°F	"P2 ON" 4:00 PM at 72°F
"P2 OFF" 10:00 PM	"P2 OFF" 10:00 PM

The user may override the program function by putting the remote in MANUAL ON mode. When the user turns the remote back to OFF mode, the remote will resume regular program mode (the word PROGRAM is above the display time, see Fig. 9). To turn the program function OFF, touch the **PROGRAM** (bottom) portion on the touchscreen, or press the **PROG** Button at the bottom of the transmitter. The word PROGRAM will disappear from the LCD screen.

EDITING PROGRAM SETTINGS

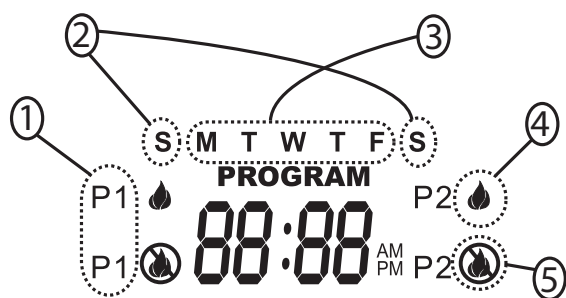

Fig. 9 Edit segments.

- Program Segment:** (P1) Program 1 (left side of LCD screen), or (P2) Program 2 (right side of LCD screen).
- Weekend Segment:** Saturday and Sunday.
- Weekday Segment:** Monday through Friday.
- Flame ON:** Flame icon shows your appliance to turn ON.
- Flame OFF:** Flame icon shows your appliance to turn OFF.

**NOTE: P1 CAN ONLY BE SET FROM 12:00AM to 12:00PM
P2 CAN ONLY BE SET FROM 12:00PM to 12:00 AM**

To edit the program settings press either the **PROG** button or touch the Program section of the touch screen and hold for 5 seconds, the program section of the LCD screen will begin to flash.

- P1 ON and "S S" (Weekend Segment) should be flashing. Select the time you want your appliance to turn ON by using the **UP** and **DOWN** touch buttons. Then press **SET** (See Fig. 10).
- P1 OFF will be flashing. Select the time you want your appliance to turn OFF. Then press **SET** (See Fig. 11).
- The set temperature will begin to flash. Use the **UP** and **DOWN** touch buttons to select a temperature for P1, then press **SET** (See Fig. 12).
- Now the P2 ON will begin to flash. Select the time you want your appliance to turn ON by using the **UP** and **DOWN** touch buttons. Then press **SET**. (See Fig. 13).
- P2 OFF will be flashing. Select a time you want your appliance to turn OFF. Then press **SET** (See Fig. 14).
- The set temperature will begin to flash. Use the **UP** and **DOWN** touch buttons to select a temperature for P2, then press **SET** (See Fig. 12).
- "MTWTF" (Weekday Segment) will replace "S S". P1 ON will be flashing. Repeat the above steps to set the ON and OFF times and set temperatures for weekdays. (See Fig. 15)



Fig. 10 Program ON at 6:00AM.



Fig. 11 Program OFF at 10:00AM.

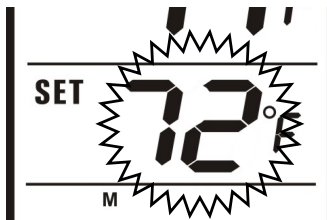

Fig. 12 Temperature set 72°F.



Fig. 13 Program ON at 5:00PM.



Fig. 14 Program OFF at 10:00PM.

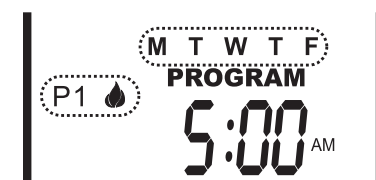

Fig. 15 Weekday segments (Mon-Fri).

	Weekends (Sat. - Sun.)			Weekdays (Mon. - Fri.)		
Program	ON	OFF	TEMP	ON	OFF	TEMP
P1						
P2						

Table 2 To record custom programming.

NOTE:

If you are in Manual Mode, then change to Program Mode during the Program Off segments, the transmitter will switch to Manual OFF.

If you are in the Thermostat Mode, then change to Program Mode during the Program OFF segments, the transmitter will switch back to Thermostat mode.

To turn the Program Mode OFF, press the PROG button. The word PROGRAM will disappear from the LCD screen remote.

COMMUNICATION - SAFETY (C/S - TX)

This remote control has a COMMUNICATION –SAFETY function built into its software. It provides an extra margin of safety when the Transmitter is out of the normal 20-foot operating range of the receiver.

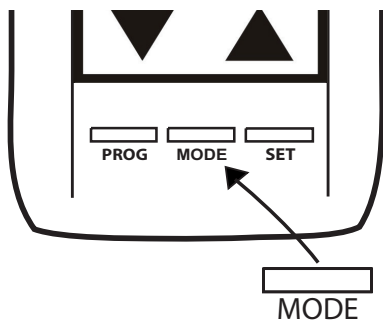
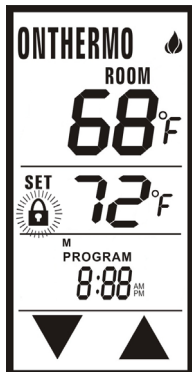

Fig. 17 Operating modes.

At all times and in all OPERATING MODES, the transmitter sends an RF signal every 15 minutes, to the receiver, indicating that the transmitter is within the normal operating range of 20-feet. Should the receiver NOT receive a transmitter signal every 15 minutes, the receiver will begin a 2 hour (120 minute) countdown timing function. If during this 2-hour period, the receiver does not receive a signal from the transmitter, the receiver will shut down the appliance being controlled by the receiver. The receiver will then emit a series of rapid “beeps” for a period of 10 seconds. Then after 10 seconds of rapid beeping, the receiver will continue to emit a single “beep” every 4 seconds until a transmitter MODE button is pressed to reset the receiver.

CHILDPROOF “LOCK-OUT” - (CP)



This remote control includes a CHILDPROOF “LOCK-OUT” feature that allows the user to “LOCK-OUT” operation of the appliance from the TRANSMITTER.

- To activate the “LOCK-OUT” feature, press and hold the **UP** touch button and the **SET** button together for 5 seconds. The lock icon will appear on the LCD screen.
- To disengage the “LOCK-OUT”, press and hold the **UP** touch button and the **SET** button together for 5 seconds or more, the lock icon will disappear from the LCD screen and the transmitter will return to its normal operating condition.
- When the Transmitter is in “LOCK-OUT” mode, programmed functions will go on without interruption; Only manual functions are prevented.

Fig. 18 Childproof lock-out.

SETTING THE TEMPERATURE SWING (TEMPERATURE DIFFERENTIAL)

The Thermo Mode on the transmitter operates the appliance whenever the room temperature varies a certain number of degrees from the set temperature. This variation is called the “**SWING**” or **TEMPERATURE DIFFERENTIAL**. The factory preset swing temperature is 2° F (1° C). To change the “Swing Setting:”

- Press the **SET** button and the **DOWN** touch button simultaneously to display the current “swing” setting in the set temp frame. The letter “S” will display in the room temp frame on the LCD screen.
- Press the **UP** or **DOWN** touch button to adjust the “SWING” temperature (1°- 3° F) (1°- 2° C).
- To store the “swing” setting press the **SET** button, and the new “swing” setting will be automatically programmed.

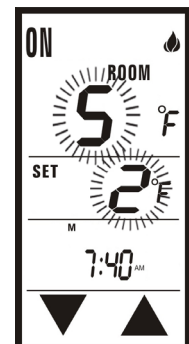

Fig. 16 Swing setting.

TRANSMITTER WALL MOUNT BRACKET

The transmitter can be placed on a wall using the mount provided.

- Wood - Drill 1/8" pilot holes and install with screws provided.
- Plaster/Wallboard - Drill 1/4" holes, use a hammer to tap in the two plastic anchors. Then install with the screws provided.

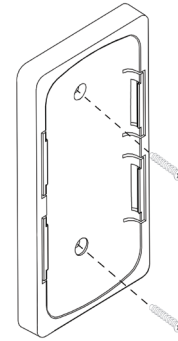

Fig. 19 Wall plate mounting.

WARNING

This remote control system must be installed exactly as outlined in these instructions. Read all instructions completely before attempting installation. Follow instructions carefully during installation. Any modifications of this remote control or any of its components will void the warranty and may pose a fire hazard.

Do not connect any gas valve or electronic module directly to 110-120VAC power. Consult gas appliance manufacturer's instructions and wiring schematics for proper placement of all wires. All electronic modules are to be wired to manufacturer's specifications.

The following wiring diagrams are for illustration purpose only. Follow instructions from manufacturer of gas valve and/or electronic module for correct wiring procedures. Improper installation of electric components can cause damage to electronic module, gas valve and remote receiver.

INSTALLATION

The remote receiver can be either wall-mounted in a standard plastic switch box (not metal) or placed on or near the fireplace hearth. Preferably, the remote receiver should be wall-mounted in a plastic switch box, as this will protect its electronic components from the heat produced by the gas appliance. The remote receiver should be kept away from temperatures exceeding 130° F. Battery life is also significantly shortened if batteries are exposed to temperatures 130° F or higher.

Before installation make sure the remote receiver slide switch is in the **OFF** position. After installation be sure that the slide switch is moved to the **REMOTE** position.

MOUNTING THE REMOTE RECEIVER

WALL MOUNT

When wall mounting the remote receiver, longer wires (not included) are required to connect to the gas valve or electronic module. These wires must:

- Be at least 18 Gauge (AWG)
- Be no longer than 20-feet
- Have no splices

To attach Cover Plate to Receiver Box: Position the receiver as shown in diagram to the left with lower tab on cover plate inserted into groove of receiver (Make sure LEARN hole on cover plate properly aligns with remote receiver). Pull receiver up and snap into top tab of cover plate.

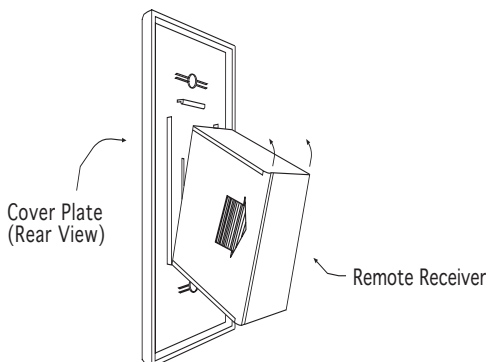

Fig. 20 Mounting receiver to cover plate.

Position the cover plate so the word ON is facing up; then, install the remote receiver into the plastic switch-box using the two long screws provided. Push the white button over the receiver slide switch.

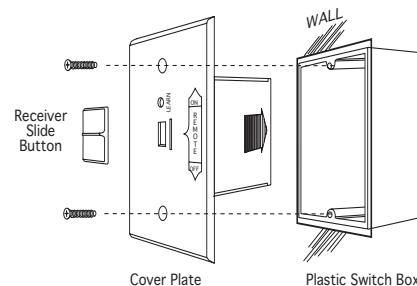

Fig. 21 Installing receiver into junction box.

HEARTH MOUNT

- The remote receiver can be placed on the fireplace hearth or under the fireplace behind the control access panel.
- Use the wires attached to the remote receiver to connect to the gas valve or the electric module (piggyback connectors have both male & female terminals for flexibility).
- Be sure that the connectors do not touch each other or other bare metal surfaces; this will cause the appliance to turn ON. The connectors may be wrapped with electrical tape to prevent this.

WIRING INSTRUCTIONS

A qualified electrician should install the remote control system.

WIRING MILLIVOLT VALVES

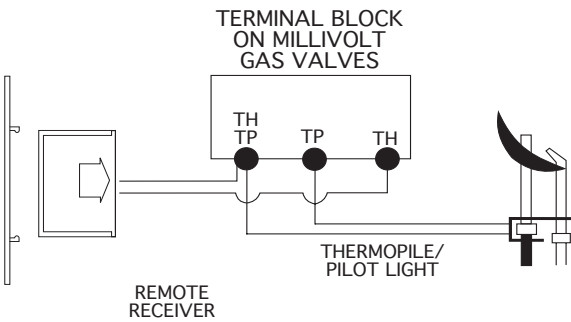

Fig. 23 Millivolt wiring.

MILLIVOLT SYSTEM CHECK

- Ensure that the pilot flame is lit.
- Slide the 3-position button on the remote receiver to the **ON** position. The main gas flame (i.e., the fire) should ignite.
- Slide the button to **OFF**. The main flame should extinguish (the pilot flame will remain ON).
- Slide the button to **REMOTE**, then press the **ON** button on the transmitter to change the system to ON. The main gas flame should ignite.

WIRING ELECTRONIC SPARK IGNITIONS

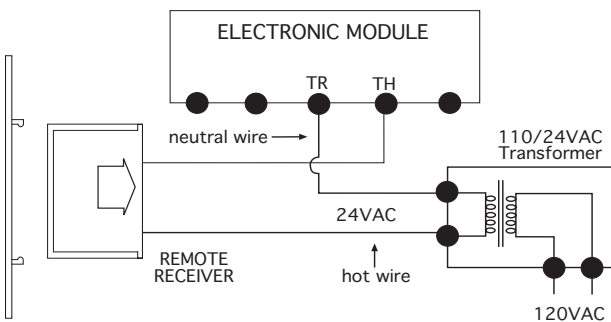

Fig. 24 Electronic wiring.

ELECTRONIC SPARK SYSTEM CHECK

- Slide the 3-position button on the remote receiver to the **ON** position. The spark electrode should begin sparking to ignite the pilot. After the pilot flame is lit, the main gas valve should open and the main gas flame should ignite.
- Slide the button to **OFF**. The main gas flame and pilot flame should both extinguish.
- Slide the button to **REMOTE**, then press the **ON** button on the transmitter to change the system to ON. The spark electrode should begin sparking to ignite the pilot. After the pilot is lit, the main gas valve should open and the main gas flame should ignite.

Remote Receiver

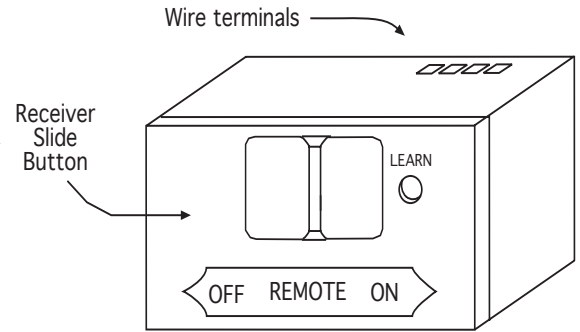

Fig. 22 Receiver sitting on hearth.

- Connect one wire from the remote receiver to the TH terminal on the gas valve.
- Connect the other wire from the remote receiver to the TH/TP terminal on the gas valve.

The remote control receiver can be connected, in series, to a 24VAC transformer to the TR (transformer) terminal on the ELECTRONIC MODULE. Connect the hot wire from the 24VAC transformer to either of the wire terminals on the remote receiver. Connect another wire between the other receiver wire terminal and the TH (thermostat) terminal on the ELECTRONIC MODULE.

RECEIVER

Install the (4) AA-size batteries supplied with the unit. It is recommended that ALKALINE batteries always be used for this product. **Be sure the batteries are installed with the (+) and (-) ends facing the correct direction.**

The remote receiver has a 3-position slide switch for selecting the mode of operation **ON/REMOTE/OFF**

- **ON:** will manually turn ON the appliance.
- **REMOTE:** will allow use of handheld transmitter. If the system does not respond to the transmitter on initial use, check the battery positions in the remote. If that does not work, see LEARNING TRANSMITTER TO RECEIVER section.
- **OFF:** will disable the remote receiver.
- **It is suggested that the slide switch be placed in the OFF position if you will be away from your home for an extended period of time.**

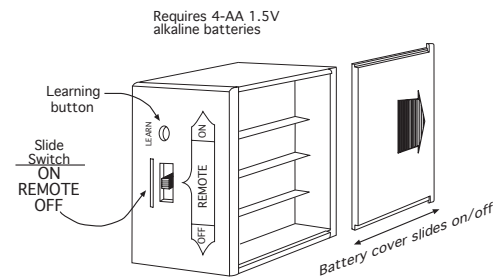

Fig. 25 Receiver operation.

LEARNING TRANSMITTER TO RECEIVER

Each transmitter uses a unique security code. It will be necessary to press the LEARN button on the receiver to accept the transmitter security code upon initial use, if batteries are replaced, or if a replacement transmitter is purchased from your dealer or the factory. In order for the receiver to accept the transmitter security code, be sure the slide button on the receiver is in the REMOTE position; the receiver will not LEARN if the slide switch is in the ON or OFF position. The LEARN button is located on the front face of the receiver; inside the small hole labeled LEARN. Using a small screwdriver or end of a paperclip gently Press and Release the black LEARN button inside the hole. When you release the LEARN button the receiver will emit an audible "beep". After the receiver emits the beep press the transmitter MODE button and release. The receiver will emit several beeps indicating that the transmitter's code has been accepted into the receiver.

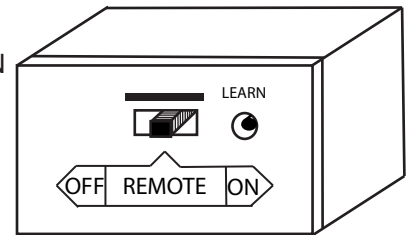

Fig. 26 Receiver switches.

THERMO SAFETY FEATURE

If the receiver at anytime should reach 130°F, the receiver will automatically shut down and begin to beep 3 beeps every 2 seconds. Once the temperature has dropped between 120°F and 130°F, the user can reactivate the appliance by pressing the MODE button, but the beeping will continue until temperatures drop below 120°F. This is to tell the user that the receiver needs to be relocated to reduce temperatures.

If this situation happens, the receiver should be placed somewhere else where it will not reach temperatures in excess of 130°F.

BATTERY LIFE

Life expectancy of the alkaline batteries in the transmitter and receiver should be at least 12 months. Check and replace all batteries:

- Annually.
- When operating range becomes reduced.
- When transmissions are not received by the remote receiver.
- If the remote receiver batteries measure less than 5.3 volts (all (4) batteries in combination).
- If the hand held transmitter batteries measure less than 5.3 volts all (4) batteries in combination).

TROUBLE SHOOTING

If you encounter problems with your fireplace system, the problem may be with either the fireplace itself or with the remote. Review the fireplace manufacturer's operation manual to make sure all connections are properly made. Then check the operation of the remote in the following manner:

- Make sure all batteries are correctly installed in the transmitter and receiver. Also check that the batteries are fully charged.
- Check batteries in transmitter to ensure contacts are touching (+) and (-) ends of battery. Bend metal contacts in for tighter fit.
- Be sure receiver and transmitter is within 20 to 25-foot operating range.
- Keep receiver from temperatures exceeding 130° F. Battery life will be shortened if exposed to high temperatures.
- If receiver is installed in a tightly enclosed metal surrounding, the operating distance will be shortened.
- Make sure the hand-held transmitter and remote receiver are communicating properly (see LEARNING TRANSMITTER TO RECEIVER section above).

FCC REQUIREMENTS

NOTE: THE MANUFACTURER IS NOT RESPONSIBLE FOR ANY RADIO OR TV INTERFERENCE CAUSED BY UNAUTHORIZED MODIFICATIONS TO THE EQUIPMENT. SUCH MODIFICATIONS COULD VOID THE USER'S AUTHORITY TO OPERATE THE EQUIPMENT

Federal Communication Commission Interference Statement

This device complies with part 15 of the FCC Rules. Operation is subject to the following two conditions:

(1) This device may not cause harmful interference, and (2) this device must accept any interference received, including interference that may cause undesired operation.

Note: This equipment has been tested and found to comply with the limits for a Class B digital device, pursuant to part 15 of the FCC Rules. These limits are designed to provide reasonable protection against harmful interference in a residential installation. This equipment generates, uses and can radiate radio frequency energy and, if not installed and used in accordance with the instructions, may cause harmful interference to radio communications. However, there is no guarantee that interference will not occur in a particular installation. If this equipment does cause harmful interference to radio or television reception, which can be determined by turning the equipment off and on, the user is encouraged to try to correct the interference by one or more of the following measures:

—Reorient or relocate the receiving antenna.

—Increase the separation between the equipment and receiver.

—Connect the equipment into an outlet on a circuit different from that to which the receiver is connected.

—Consult the dealer or an experienced radio/TV technician for help.

Note: The Grantee is not responsible for any changes or modifications not expressly approved by the party responsible for compliance. such modifications could void the user's authority to operate the equipment.

RF Warning

The device has been evaluated to meet general RF exposure requirement. This equipment complies with FCC's RF radiation exposure limits set forth for an uncontrolled environment. This device and its antenna(s) must not be co-located or conjunction with any other antenna or transmitter.

IC Warning

This device complies with Industry Canada license-exempt RSS standard(s).

Operation is subject to the following two conditions: (1) this device may not cause interference, and (2) this device must accept any interference, including interference that may cause undesired operation of the device.

Le présent appareil est conforme aux CNR d'Industrie Canada applicables aux appareils radio exempts de licence.

L'exploitation est autorisée aux deux conditions suivantes : (1) l'appareil ne doit pas produire de brouillage, et (2) l'utilisateur de l'appareil doit accepter tout brouillage radioélectrique subi, même si le brouillage est susceptible d'en compromettre le fonctionnement.

**FOR TECHNICAL
SERVICE, CALL:**

U.S. INQUIRIES
(855) 498-8324 or (260) 459-1703

CANADIAN INQUIRIES
(877) 472-3923

Skytech Products Group
9230 Conservation Way
Fort Wayne, IN 46809
Sales Support: (888) 699-6167
Website: www.skytechpg.com

MANUFACTURED EXCLUSIVELY FOR SKYTECH II, INC



LIMITED WARRANTY

1. **Limited Warranty.** Skytech II, Inc. (“Skytech”) warrants that each new Skytech Control System, including all hardware, parts and components (the “System”), when used in accordance with the instructions furnished by Skytech provided with each System, shall be free in all material respects, of defects in materials and any workmanship under normal use, subject to proper installation (“Limited Warranty”). This Limited Warranty is non-transferrable and sets forth our sole and exclusive liability and the sole and exclusive remedies available in relationship to any nonconformity, defect or similar claim. This Limited Warranty only extends to the original retail purchaser of the System (the “Customer”) and expires upon any sale or transfer of the home where the System is installed by the Customer.
2. **System Sold As Is.** Subject to this Warranty and any applicable state law, each System is sold by Skytech to a Customers, limitations, reservations of rights, exclusions, and qualifications set forth on Skytech’s website, www.skytechpg.com, all of which are considered part of the Warranty and are incorporated herein (collectively, the “Additional Terms”). Each Customer, by purchasing and/or using any System or any portion thereof, does so subject to the Warranty and the Additional Terms.
3. **Installation and Use of System.** Improper Installation, adjustment, alteration, service, or maintenance can cause property damage, personal injury, or loss of life. Thoroughly read the installation and operating instructions of this Control as well as the appliance it will be used in conjunction with as a system. If applicable, read the maintenance instructions before installing this control. This product is designed for use with an attended hearth appliance or fire feature. Adults must be present when the Control System is operating. DO NOT program or thermostatically set this Control to operate a hearth appliance or fire feature when Adults are not physically present. Furthermore, DO NOT leave the hearth appliance or fire feature burning unattended; it may cause damage or serious injury. If an Adult is going to be away from the hearth appliance or fire feature for any length of time, then the handheld/wall mount, receiver/control module and application should be in the “OFF” position.
4. **Repair or Replacement of System or Parts.** Should any System, or any hardware, components and/or parts contained therein fail due to a defect in workmanship or material provided by Skytech after the purchase of a System by a Customer, Skytech shall repair or, at its option, replace the defective System or part, hardware or component, subject to the Customer’s compliance with all terms and conditions contained herein governing service and claims under the Warranty. Skytech shall provide replacement parts at no charge for the first (5) five years of this warranty, and at market cost for the Lifetime of the product to the original Customer. Gas valve and gas valve components will be available at no charge for one (1) year. If Skytech does not have the parts for an individual model, then a comparable replacement System will be provided at no charge within the first (5) five years after purchase, and then at market cost for the Lifetime of that product to the Customer.
5. **Warranty Claims; Skytech Service.** To submit a valid claim under the Warranty (each, a “Valid Claim”), a Customer must comply with the following:
 - a) Obtain a Return Material Authorization (“RMA”) number from Skytech by calling (855) 498-8324; and
 - b) Provide written notice to a Skytech or an Authorized Dealer (“Dealer”) and provide the Name, House Address, Email Address and Telephone Number of the Customer;
 - c) Describe the System model number and nature of the defect, nonconformity, or other problem with the System;
 - d) Provide such notice within thirty (30) days of discovery of such defect, nonconformity, or problem;
 - e) securely pack and ship the defective Skytech Product to Skytech II, Inc. ATTN: Warranty Department at 9230 Conservation, Fort Wayne, IN 46809. Customer assumes all costs and risks associated with transportation to Skytech (i) the RMA number is only valid for thirty (30) days from the date the RMA was issued, (ii) the RMA number should be clearly marked on the outside of each box being returned. Skytech may refuse shipments that DO NOT meet all of the Valid Claim requirements. Skytech is not responsible for any refused shipments or any damage caused due to shipping, whether or not it was a Valid Claim. Skytech shall be responsible for return shipment charges. Compliance with these requirements is a condition to coverage under this Limited Warranty.

Skytech may refuse any shipment(s) that does not meet all of the Valid Claim requirements. Skytech is not responsible for any refused shipments or any damage caused due to shipping, whether or not it was a Valid Claim. Skytech shall be responsible for reasonable return shipment charges for any Skytech System returned whether or not Skytech determines there is no defect with the System, reject for failure of the Customer to submit a Valid Claim, or otherwise determine is not eligible for service under the Warranty.

Upon receipt of a Valid Claim and the properly-returned System, Skytech shall, at its option, either (a) repair the System, at no charge to the Customer, or (b) replace the returned System with a new comparable System, at no charge to the Customer, or (c) provide the Customer with a refund in an amount equal to the price paid by the Customer for the defective System not including any service or labor cost associated with the installation or otherwise. Any System on

hardware, component or part repaired by Skytech hereunder, or any replacement System, hardware, component or part shall be shipped to the Customer by Skytech at Skytech's cost and the Warranty, the Additional Terms, and all other terms and conditions set forth herein shall extend to such repaired or replacement System, hardware, component or part. Skytech shall pay no refund before Skytech from the Customer receives the defective System, hardware, component and/or parts. Any obligation of Skytech under this Section 4 shall be and remain subject to Skytech's right to physically inspect the defective System, hardware, component and/or part returned to Skytech by the Customer. Some States do not allow the exclusion or limitation of incidental and consequential damages or limitation on how long an implied warranty lasts, so the above limitation may not apply to you. This warranty gives you specific rights and you may have other rights, which vary from state, province, or nation. To the extent allowable under any law, the liability of Skytech is limited to the express terms of this warranty, and Skytech expressly disclaims any and all implied warranties, including any warranties of fitness for a particular purpose or merchantability.

REV. 2-24-17



Print information and detach at dotted line and return to: Skytech Products Group, Attn. Warranty Dept.,
9230 Conservation Way, Fort Wayne, IN 46809 Phone: (855)498-8224

Warranty Information

Purchase Date: _____ Model: _____ Date Code: _____

Purchased From: _____

Customer Name: _____ Phone: _____

Address: _____

City: _____ State/Prov. _____ Zip/Postal Code _____

E-mail Address: _____

Back of remote date code sample

19	●	1	2	3	4	5	6
20		7	8	9	10	11	12

1-12 indicates Month remote was produced.
19-20 indicates Year remote was produced.
Sample date codes above is 1911

Please send a Proof of Purchase (original receipt) copy along with your warranty form.