



# HOMEOWNER'S CARE AND OPERATION INSTRUCTIONS



DR-500 MODEL SHOWN

RETAIN THESE INSTRUCTIONS FOR FUTURE REFERENCE



OMNI-Test Laboratories, Inc.

OTL Report No. 116-F-13-4

**WARNING: IF THE INFORMATION IN THIS MANUAL IS NOT FOLLOWED EXACTLY, A FIRE OR EXPLOSION MAY RESULT CAUSING PROPERTY DAMAGE, PERSONAL INJURY OR LOSS OF LIFE.**

**FOR YOUR SAFETY:** Do not store or use gasoline or other flammable vapors or liquids in the vicinity of this or any other appliance.

**FOR YOUR SAFETY:** What to do if you smell gas:

- DO NOT light any appliance.
- DO NOT touch any electrical switches.
- DO NOT use any phone in your building.
- Immediately call your gas supplier from a neighbor's phone.

Follow your gas suppliers instructions.

- If your gas supplier cannot be reached, call the fire department.

Installation and service must be performed by a qualified installer, service agency or the gas supplier.

## DIRECT-VENT 500/600/800 SERIES

VENTED GAS FIREPLACE HEATERS - DIRECT VENT MODELS  
P/N 725,032M REV. H 11/2004

### MODELS

#### Millivolt Models

D-500CMN	DT-600CMP
D-500CMP	DR-600CMN
DT-500CMN	DR-600CMP
DT-500CMP	D-800CMN
DR-500CMN	D-800CMP
DR-500CMP	DT-800CMN
D-600CMN	DT-800CMP
D-600CMP	DR-800CMN
DT-600CMN	DR-800CMP

#### Electronic Models

D-500CEN	DT-600CEP
D-500CEP	DR-600CEN
DT-500CEN	DR-600CEP
DT-500CEP	D-800CEN
DR-500CEN	D-800CEP
DR-500CEP	DT-800CEN
D-600CEN	DT-800CEP
D-600CEP	DR-800CEN
DT-600CEN	DR-800CEP

**AVERTISSEMENT: ASSUREZ-VOUS DE BIEN SUIVRE LES INSTRUCTIONS DONNÉ DANS CETTE NOTICE POUR RÉDUIRE AU MINIMUM LE RISQUE D'INCENDIE OU POUR ÉVITER TOUT DOMMAGE MATÉRIEL, TOUTE BLESSURE OU LA MORT.**

**POUR VOTRE SÉCURITÉ:** Ne pas entreposer ni utiliser d'essence ni d'autre vapeurs ou liquides inflammables dans le voisinage de cet appareil ou de tout autre appareil.

**POUR VOTRE SÉCURITÉ:** Que faire si vous sentez une odeur de gaz:

- Ne pas tenter d'allumer d'appareil.
- Ne touchez à aucun interrupteur. Ne pas vous servir des téléphones se trouvant dans le bâtiment où vous vous trouvez.
- Evacuez la pièce, le bâtiment ou la zone.
- Appelez immédiatement votre fournisseur de gaz depuis un voisin. Suivez les instructions du fournisseur.
- Si vous ne pouvez rejoindre le fournisseur de gaz, appelez le service des incendies.

L'installation et service doit être exécuté par un qualifié installateur, agence de service ou le fournisseur de gaz.

## CONGRATULATIONS!

In selecting this SUPERIOR Direct-Vent Gas Appliance you have chosen the finest and most dependable fireplace to be found anywhere. A beautiful, prestigious, alternative to a wood burning fireplace. Welcome to a Family of tens of thousands of satisfied SUPERIOR Fireplace Owners.

Please read and carefully follow all of the instructions found in this manual. Please pay special attention to the safety instructions provided in this manual. The Homeowner's Care and Operation Instructions included here will assure that you have many years of dependable and enjoyable service from your SUPERIOR product.

## TABLE OF CONTENTS

Introduction .....	page 2
General Information .....	page 2
Operation/Care of Your Appliance ....	page 3
Control Compartment Access .....	page 3
Variable Flame Adjustment .....	page 4
Glass Cleaning .....	page 4
Maintenance .....	page 4
Maintenance Schedule .....	page 5
Front Glass Enclosure Panel, Removal and Installation .....	page 6
Burner Adjustments .....	page 6
Flame Appearance and Sooting .....	page 6
Adjustment .....	page 6
Log Placement .....	page 7
Rockwool Placement .....	page 8
Vermiculite Placement .....	page 8
Volcanic Stone Placement .....	page 8
Millivolt Appliance Checkout .....	page 8
Electronic Appliance Checkout .....	page 8
Wiring Diagrams .....	page 9
Warranty .....	page 9
Replacement Parts .....	page 9
Product Reference Information .....	page 9
Accessory Components .....	page 10
Lighting Instructions – Millivolt .....	page 12
Lighting Instructions – Electronic ...	page 14
Troubleshooting Guide – Millivolt ....	page 16
Troubleshooting Guide – Electronic ..	page 17
Replacement Parts List .....	page 18

## INTRODUCTION

The Fireplace models covered in this manual are Direct-Vent sealed combustion vented gas fireplace heaters designed for residential application. Direct-Vent appliances operate with the combustion chamber completely isolated from the inside atmosphere. All air for combustion is brought in from the outside and exhaust gases are vented through the same direct vent, vent system.

The millivolt appliances are designed to operate on either natural or propane gas. A millivolt gas control valve with piezo ignition system provides safe, efficient operation. External electrical power is required to operate the optional electrically powered components if installed. Electrical power must be wired during appliance installation.

The electronic appliances are designed to operate on either natural or propane gas. An electronic intermittent pilot system provides safe, efficient operation. External electrical power is required to operate these units.

These appliances comply with National Safety Standards and are tested and listed by Omni-Test Laboratories (Report No. 116-F-13-4) to ANSI Z21.88-2002 (in Canada, CSA-2.33-2002), and CAN/CGA-2.17-M91 in both USA and Canada, as vented gas fireplace heaters.

Installation must conform to local codes. In the absence of local codes, installation must comply with the current National Fuel Gas Code, ANSI Z223.1 (NFPA 54). (In Canada, the current CAN/CGAB149 installation code.) Electrical wiring must comply with local codes. In the absence of local codes, installation must be in accordance with the National Electrical Code, NFPA 70 - (latest edition). (In Canada, the current CSA C22.1 Canadian Electric Code.)

**DO NOT ATTEMPT TO ALTER OR MODIFY THE CONSTRUCTION OF THE APPLIANCE OR ITS COMPONENTS. ANY MODIFICATION OR ALTERATION MAY VOID THE WARRANTY, CERTIFICATION AND LISTINGS OF THIS UNIT.**

**WARNING: IMPROPER INSTALLATION, ADJUSTMENT, ALTERATION, SERVICE OR MAINTENANCE CAN CAUSE INJURY OR PROPERTY DAMAGE. REFER TO THIS MANUAL. FOR ASSISTANCE OR ADDITIONAL INFORMATION CONSULT A QUALIFIED INSTALLER, SERVICE AGENCY OR THE GAS SUPPLIER.**

## GENERAL INFORMATION

**Note:** Installation and repair should be performed by a qualified service person. The appliance should be inspected annually by a qualified professional service technician. More frequent inspections and cleanings may be required due to excessive lint from carpeting, bedding material, etc. It is imperative that the control compartment, burners and circulating air passage ways of the appliance be kept clean.

*S'assurer que le brûleur et le compartiment des commandes sont propres. Voir les instructions d'installation et d'utilisation qui accompagnent l'appareil.*

Provide adequate clearances around air openings and adequate accessibility clearance for service and proper operation. Never obstruct the front openings of the appliance.

Due to high temperatures the appliance should be located out of traffic and away from furniture and draperies. Locate furniture and window coverings accordingly.

**WARNING: THESE FIREPLACES ARE VENTED HEATERS. DO NOT BURN WOOD OR OTHER MATERIAL IN THESE APPLIANCES.**

**These appliances are designed to operate on natural or propane gas only.**

Input of millivolt models is variable. These rates are shown in the following table:

Millivolt Models with Manually-Modulated Gas Valve			
Natural Gas		Propane Gas	
D, DT, DR Series	Input rate (BTU/H)	D, DT, DR Series	Input rate (BTU/H)
500	17,500 to 23,000	500	17,500 to 23,000
600	21,500 to 29,000	600	22,500 to 29,000
800	24,000 to 32,000	800	25,500 to 32,000

### Electronic Models -

Electronic models have a fixed rate gas valve. Input of electronic models is shown in the following table:

Electronic Models with Fixed-Rate Gas Valve	
Natural and Propane Gas	
D, DT, DR Series	Input rate (BTU/H)
500	23,000
600	29,000
800	32,000

The following table shows the units' orifice size for the elevations indicated.

BD, BD-T, BD-R Series	Orifice Size		Elevation Feet (Meters)
	Nat.	Prop.	
35	0.090 in.	#54	0-4500 (0-1370)
40	#36	#52	
45	#33	0.065 in.	

Maximum manifold pressure is 3.5 in. w.c. (0.87 kPa) for natural gas and 10 in. w.c. (2.49 kPa) for LP/Propane gas.

Do not use these appliances if any part has been under water. Immediately call a qualified, professional service technician to inspect the appliance and to replace any parts of the control system and any gas control which have been under water.

Ne pas se servir de cet appareil s'il a été plongé dans l'eau, complètement ou en partie. Appeler un technicien qualifié pour inspecter l'appareil et remplacer toute partie du système de contrôle et toute commande qui ont été plongés dans l'eau.

Test gage connections are provided on the front of the millivolt gas control valve (identified OUT for the manifold side and IN for inlet pressure. A 1/8" NPT test gage connection is provided on the electronic gas control valve adjacent to the outlet to the main burner.

Minimum inlet gas pressure to these appliances is 5.0 inches water column (1.24 kPa) for natural gas and 11 inches water column (2.74 kPa) for propane for the purpose of input adjustment.

Maximum inlet gas supply pressure to these appliances is 10.5 inches water column (2.61 kPa) for natural gas and 13.0 inches water column (3.23 kPa) for propane.

The appliance must be isolated from the gas supply piping system (by closing its individual manual shut-off valve) during any pressure testing of the gas supply piping system at test pressures equal to or less than 1/2 psig (3.5 kPa).

The appliance and its individual shut-off valve must be disconnected from the gas supply piping system during any pressure testing of that system at pressures in excess of 1/2 psig (3.5 kPa).

These appliances must not be connected to a chimney or flue serving a separate solid fuel burning appliance.

Any safety guard or screen removed for servicing the appliance must be replaced prior to operating the appliance.

**WARNING: FAILURE TO COMPLY WITH THE INSTALLATION AND OPERATING INSTRUCTIONS PROVIDED IN THIS DOCUMENT WILL RESULT IN AN IMPROPERLY INSTALLED AND OPERATING APPLIANCE, VOIDING ITS WARRANTY. ANY CHANGE TO THIS APPLIANCE AND/OR ITS OPERATING CONTROLS IS DANGEROUS. IMPROPER INSTALLATION OR USE OF THIS APPLIANCE CAN CAUSE SERIOUS INJURY OR DEATH FROM FIRE, BURNS, EXPLOSION OR CARBON MONOXIDE POISONING.**

**Carbon Monoxide Poisoning: Early signs of carbon monoxide poisoning are similar to the flu with headaches, dizziness and/or nausea. If you have these signs, obtain fresh air immediately. Turn off the gas supply to the appliance and have it serviced by a qualified professional, as it may not be operating correctly.**

**WARNING: CHILDREN AND ADULTS SHOULD BE ALERTED TO THE HAZARDS OF HIGH SURFACE TEMPERATURES. USE CAUTION AROUND THE APPLIANCE TO AVOID BURNS OR CLOTHING IGNITION. YOUNG CHILDREN SHOULD BE CAREFULLY SUPERVISED WHEN THEY ARE IN THE SAME ROOM AS THE APPLIANCE.**

**WARNING: DO NOT PLACE CLOTHING OR OTHER FLAMMABLE MATERIALS ON OR NEAR THIS APPLIANCE.**

**AVERTISSEMENT: SURVEILLER LES ENFANTS. GARDER LES VÊTEMENTS, LES MEUBLES, L'ESSENCE OU AUTRES LIQUIDES À VAPEUR INFLAMMABLES LOIN DE L'APPAREIL.**

### OPERATION AND CARE OF YOUR APPLIANCE

Appliance operation may be controlled through a remotely located optional wall switch. Separate switches may provide independent control for the remote controlled fireplace operation (optional equipment).

In lieu of remote or remote wall switch operation, the appliance must be operated directly through the controls located on the front of the valve located within the control compartment which is located behind the control compartment access panel below the appliance front glass enclosure panel. See *Figure 1*.

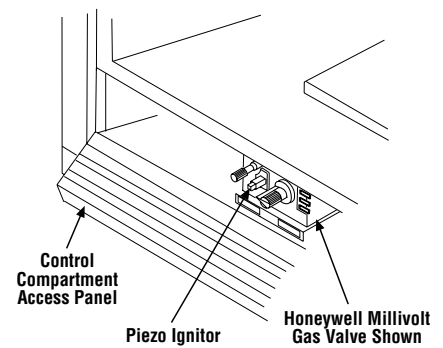

**Control Compartment Access - Millivolt Control Valve Shown**

*Figure 1*

### Gas Controls/Control Compartment Access

The gas controls can be found behind the control compartment access panel. To open the control compartment access panel, actuate the spring-loaded magnetic catches securing the panel, by gently depressing the outer top corners of the panel until the catches "pop" the door free, allowing it to swing out and down to open.

Operation of millivolt and electronic gas control systems are different. Before lighting and operating your appliance determine if you have a millivolt or electronic appliance. See *Figure 1* for access to the control compartment.

Millivolt appliances will be fitted with the gas control valve shown in *Figure 3 (SIT)* or *Figure 4 (Honeywell)* on page 4. Appliances with electronic systems will be fitted with the electronic valve shown in *Figure 2 on page 4*.

Familiarize yourself with the gas control valve that your appliance uses.

### Millivolt Appliances -

To light millivolt appliances refer to the detailed lighting instructions found on *page 12 (English)* and *page 13 (French)*. Millivolt appliance lighting instructions may also be found on the pull-out lighting instruction labels attached to the gas control valve. Refer to *Figure 2 (SIT)*, *3 (Honeywell)* on page 4 for the location of the piezo ignitor.

Millivolt appliances may be fitted with an optional burner ON/OFF Rocker Switch. The optional ON/OFF Rocker switch will be installed in the bracket just beneath the gas control valve. Once the pilot is lit, the ON/OFF rocker switch will control the appliance ON/OFF operation. To operate: Toggle the switch between its ON and OFF positions.

If your millivolt appliance is equipped with an optional remote wall switch or remote control kit and the pilot is lit, the appliance main burner may be turned on and off with the wall switch or remote control.

NOTE: DIAGRAMS & ILLUSTRATIONS NOT TO SCALE.

## Electronic Appliances -

To light electronic appliances refer to the detailed lighting instructions found in both English and French on **pages 14 and 15** of these instructions respectively. **Electronic appliance lighting instructions may also be found on the pull out lighting instruction labels attached to the gas control valve.** If your electronic appliance is equipped with an optional remote wall switch or remote control kit the appliance main burner may be turned on and off with the wall switch or remote control.

If your electronic appliance is not equipped with a wall switch or remote control, the main burner must be turned off and on with the gas control switch. Toggle the switch from ON to OFF to operate the main burner .

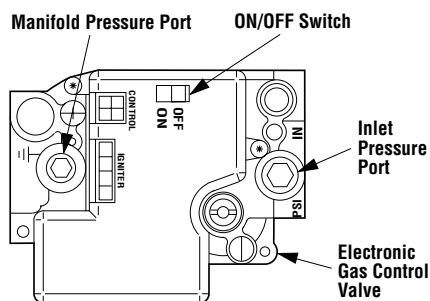

**Honeywell Electronic Gas Valve**

**Figure 2**

## Variable Flame Height Adjustment ( Millivolt Appliances only)

1. All Millivolt appliances are equipped with a variable gas control valve. Flame height for these models may be adjusted through a range between fixed low and high settings, alternately, while the appliance is in operation. Adjust the flame height as desired after lighting the appliance by rotating the variable adjustment control knob located on the front of the valve (**refer to Figure 3 - SIT, 4 - Honeywell**).

2. When lit for the first time, this appliance will emit a slight odor for an hour or two. This is due to the "burn-in" of internal paints and lubricants used in the manufacturing process.

3. Keep lower control compartment clean by vacuuming or brushing at least twice a year. More frequent cleaning may be required due to excessive lint from carpeting, bedding materials, etc. It is important that control compartments, burners and circulating air passageways of the appliance be kept clean.

4. Always turn off gas to the pilot (millivolt appliances) before cleaning. Before re-lighting, refer to the lighting instructions in this manual. Instructions are also found on a pull-out panel located on the floor of the appliance.

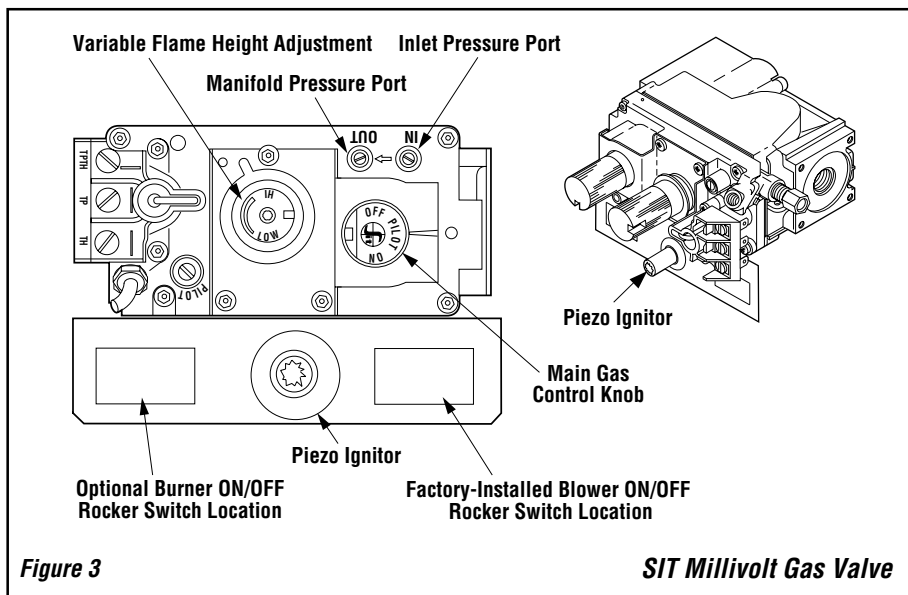

**Figure 3**

**SIT Millivolt Gas Valve**

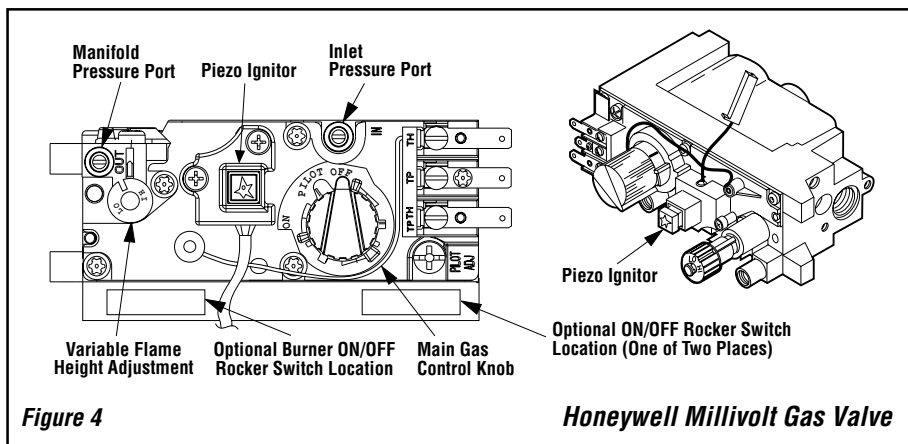

**Figure 4**

**Honeywell Millivolt Gas Valve**

5. Always keep the appliance area clear and free from combustible materials, gasoline and other flammable liquids.

6. Remember, Millivolt appliances have a continuous burning pilot flame. Exercise caution when using products with combustible vapors.

## Glass Cleaning

It will be necessary to clean the glass periodically. During start-up it is normal for condensation to form on the inside of the glass. This can cause lint, dust and other airborne particles to cling to the glass surface. Also initial paint curing may deposit a slight film on the glass. It is therefore recommended that the glass be cleaned two or three times with a non-ammonia household cleaner and warm water (a gas fireplace glass cleaner is recommended). After that the glass should be cleaned two or three times during each heating season, depending on the circumstances present.

**Note:** Clean glass after first two weeks of operation.

NOTE: DIAGRAMS & ILLUSTRATIONS NOT TO SCALE.

**WARNING: DO NOT USE ABRASIVE CLEANERS. NEVER CLEAN THE GLASS WHEN IT IS HOT.**

**CAUTION: DO NOT ATTEMPT TO TOUCH THE FRONT ENCLOSURE GLASS WITH YOUR HANDS WHILE THE FIREPLACE IS IN USE.**

## Maintenance

The appliance and venting system should be thoroughly inspected before initial use and at least annually by a qualified service technician. However, more frequent periodic inspections and cleanings should be performed by the homeowner. **Homeowner must contact a qualified service technician at once if any abnormal condition is observed.**

Refer to the maintenance schedule for maintenance tasks, procedures, periodicity and by whom they should be performed. Always verify proper operation of the appliance after servicing.

**IMPORTANT: TURN OFF GAS AND ANY ELECTRICAL POWER BEFORE SERVICING THE APPLIANCE.**



## Maintenance Schedule

### Annually (Before the onset of the Burning Season)

Maintenance Task	Accomplishing Person	Procedure
Inspecting/Cleaning Burner, Logs and Controls	Qualified Service Technician	Inspect valve and ensure it is properly operating. Check piping for leaks. Vacuum the control compartment, fireplace logs and burner area.
Check Flame Patterns and Flame Height	Qualified Service Technician	Refer to <b>Figure 7 (D, DT, DR-500)</b> , <b>8 (D, DT, DR-600)</b> or <b>9 (D, DT, DR-800)</b> on page 7 and verify the flame pattern and height displayed by the appliance conforms to the picture. Flames must not impinge on the logs.
Inspecting/Cleaning Pilot and Burner	Qualified Service Technician	Refer to <b>Figure 10 (SIT Millivolt)</b> , <b>Figure 11 (Honeywell Millivolt)</b> or <b>Figure 12 (Electronic)</b> on page 8. Remove any surface build-up on pilot and burner assembly. Wipe the pilot nozzles, ignitor/flame rod and hood. Ensure the pilot flame engulfs the flame sensor as shown.
Checking Vent System	Qualified Service Technician	Inspect the vent system at the top and at the base (within the firebox) for signs of blockage or obstruction. Look for any signs of dislocation of the vent components.
Appliance Checkout	Qualified Service Technician	Perform the appropriate appliance checkout procedure detailed in this manual.
Replacing Rockwool Ember Materials	Homeowner/Qualified Services Technician	Remove old ember materials and vacuum the screened rockwool placement area. Place new rockwool as described in this document.

### Periodically (After the Burning Season)

Maintenance Task	Accomplishing Person	Procedure
Cleaning Firebox Interior	Homeowner	Carefully remove logs, Rockwool and volcanic stone if used. Vacuum out interior of the firebox. Clean firebox walls and log grate. Replace logs, Rockwool and volcanic stone as detailed in this manual.
Check Flame Patterns and Flame Height	Homeowner	Refer to <b>Figure 7 (D, DT, DR-500)</b> , <b>8 (D, DT, DR-600)</b> or <b>9 (D, DT, DR-800)</b> on page 7 and verify the flame pattern and height displayed by the appliance conforms to the picture. Flames must not impinge on the logs.
Checking Vent System	Homeowner	Inspect the vent system at the top and at the base (within the firebox) for signs of blockage or obstruction. Look for any signs of dislocation of the vent components.
Cleaning Front Glass Enclosure Panel	Homeowner	Clean as necessary following the directions provided in this manual. <b>DO NOT TOUCH OR ATTEMPT TO CLEAN GLASS WHILE HOT.</b>

## Front Glass Enclosure Panel, Removal and Installation.

**WARNING: NEVER OPERATE THE APPLIANCE WITHOUT THE GLASS ENCLOSURE PANEL IN PLACE AND SECURE. DO NOT OPERATE APPLIANCE WITH THE FRONT GLASS PANEL CRACKED, BROKEN OR MISSING. REPLACE-MENT PANELS ARE AVAILABLE THROUGH YOUR LOCAL LENNOX DEALER AND MUST BE INSTALLED BY A LICENSED OR QUALIFIED SERVICE TECHNICIAN.**

These are direct-vent appliances. They are designed to operate only with the front glass enclosure panel properly installed. Generally, the glass enclosure panel should not be removed except to gain access to the components within the firebox, and the appliance may only be operated without the front glass enclosure panel in place for very brief periods of time during initial appliance check-out and adjustment.

**During this appliance checkout and adjustment period, a potential safety hazard exists - EXERCISE EXTREME CAUTION to prevent the occurrence of any burn injuries from the exposed flames or hot surfaces.** Also note, that while the front glass enclosure panel is removed, the flame appearance will appear to be smaller than normal.

**WARNING: HANDLE THE GLASS WITH EXTREME CARE! TEMPERED GLASS IS SUSCEPTIBLE TO DAMAGE (SCRATCHES, FOR EXAMPLE) - HANDLE GLASS DOOR (GLASS ENCLOSURE PANEL) GENTLY WHILE RE-INSTALLING IT.**

**WARNING: DO NOT ATTEMPT TO SUBSTITUTE THE MATERIALS USED ON THIS DOOR, OR REPLACE CRACKED OR BROKEN GLASS WITH ANY MATERIALS OTHER THAN THOSE PROVIDED BY THE APPLIANCE MANUFACTURER.**

**THE GLASS DOOR OF THIS APPLIANCE MUST ONLY BE REPLACED AS A COMPLETE UNIT AS PROVIDED BY THE MANUFACTURER. DO NOT ATTEMPT TO REPLACE BROKEN, CRACKED OR CHIPPED GLASS SEPARATELY.**

Refer to *Figure 5* and remove the front glass enclosure panel as follows:

1. Remove the top louver assembly or radiant panel.
2. Open the hinged drop-down control compartment access panel.
3. Locate the two (2) latches at the top of the control compartment and disengage them from the door frame's bottom Vee-flange, pulling down on their handles to open them.

4. Swing the bottom of the door out and raise it slightly to lift the top flange of the door frame away from the appliance.

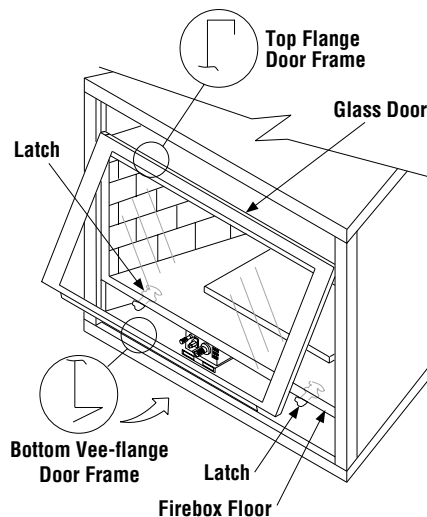

*Figure 5*

To install the front glass enclosure panel, proceed as follows:

1. Retrieve the glass door frame. Visually inspect the gasket on the backside of the panel. The gasket surface must be clean, free of irregularities and seated firmly.
2. Position the door frame in front of the firebox opening and engage the top flange over the lip at the top of the firebox opening.
3. Swing the door down and back. Ensure the gasket seats evenly as the door draws shut. Engage the Vee-flange at the bottom of the door with the latches and close the latches to secure the door.
4. Reinstall the top louver assembly or radiant panel.

## Burner Adjustments

The following paragraphs address burner adjustment concerns and procedures.

### Flame Appearance and Sooting

Proper flame appearance is a matter of taste. Generally most people prefer the warm glow of a yellow to orange flame. Appliances operated with air shutter openings that are too large will exhibit flames that are blue and transparent. These weak, blue and transparent flames are termed anemic. If the air shutter opening is too small sooting may develop.

Sooting is indicated by black puffs developing at the tips of very long orange flames. Sooting results in black deposits forming on the logs, appliance inside surfaces and on exterior surfaces adjacent to the vent termination.

Sooting is caused by incomplete combustion in the flames and a lack of combustion air entering the air shutter opening. To achieve a warm yellow to orange flame with an orange body that does not soot, the shutter opening must be adjusted between these two extremes. No smoke or soot should be present. Reposition the logs if the flames impinge on any of them.

If the logs are properly positioned and sooting conditions exist, the air shutter opening on the main burner tube should be adjusted. Normally, the more offsets in the vent system, the greater the need for the air shutter to be opened further.

**WARNING: AIR SHUTTER ADJUSTMENT SHOULD ONLY BE PERFORMED BY A QUALIFIED PROFESSIONAL SERVICE TECHNICIAN.**

**ENSURE THAT THE FRONT GLASS PANEL IS IN PLACE AND SEALED DURING ADJUSTMENT.**

### Adjustment

**CAUTION: THE ADJUSTMENT ROD AND NEARBY APPLIANCE SURFACES ARE HOT. EXERCISE CAUTION TO AVOID INJURY WHILE ADJUSTING FLAME APPEARANCE.**

To adjust the flame, move the adjustment rod (located in the lower control area) up or down to increase or reduce the air shutter opening, respectively. **Initially, always position the air shutter to the factory setting (the minimum air opening position) as shown in *Figure 6* on page 7. This can be done by pulling the adjustment rod all the way down.** Allow the burner to operate for at least 15 minutes. Observe the flame continuously. If it appears weak or sooty as previously described, adjust the air shutter by pushing or pulling on the adjustment rod until the flame appearance is as desired.

The adjustment rod and associated adjustable air shutter is patented technology. Flame adjustments can be made quickly and accurately to taste without the need of disassembling the appliance and waiting for 30 minutes after each adjustment.

Propane models may exhibit a flame pattern that may candle or appear stringy. If this is problematic or persists as the appliance is continually operated, adjust the air shutter closed as described in the previous paragraphs. Operate the appliance for a period of time as the effect diminishes, ensuring that the appliance does not develop sooty flames.

When satisfied that the appliance operates properly, proceed to finish the installation. Leave the control knob in "ON" position and turn the remote switch "OFF." Close the lower control compartment door.

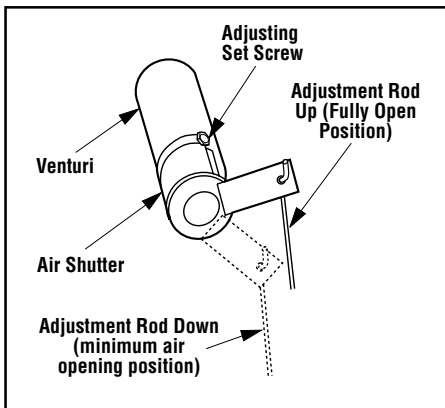

FACTORY AIR SHUTTER SETTING inches (mm)			
Models D, DT & DR	Gas Type	Applications using the Appliance Top Vent	Applications using the Appliance Rear Vent
500	Nat.	3/32 (2.38)	3/32 (2.38)
	Prop.	1/8 (3.18)	3/8 (9.52)
600	Nat.	3/32 (2.38)	3/32 (2.38)
	Prop.	3/8 (9.52)	3/8 (9.52)
800	Nat.	3/16 (4.76)	3/16 (4.76)
	Prop.	1/2 (13)	1/2 (13)

Figure 6

### Log Placement

**WARNING: LOGS GET VERY HOT AND WILL REMAIN HOT UP TO ONE HOUR AFTER GAS SUPPLY IS TURNED OFF. HANDLE ONLY WHEN LOGS ARE COOL. TURN OFF ALL ELECTRICITY TO THE APPLIANCE BEFORE YOU INSTALL GRATE AND LOGS.**

**WARNING: THIS APPLIANCE IS NOT MEANT TO BURN WOOD. ANY ATTEMPT TO DO SO COULD CAUSE IRREPARABLE DAMAGE TO YOUR APPLIANCE AND PROVE HAZARDOUS TO YOUR SAFETY.**

**WARNING: THE SIZE AND POSITION ON THE LOG SET WAS ENGINEERED TO GIVE YOUR APPLIANCE A SAFE, RELIABLE AND ATTRACTIVE FLAME PATTERN. ANY ATTEMPT TO USE A DIFFERENT LOG SET IN THE FIREPLACE WILL VOID THE WARRANTY AND WILL RESULT IN INCOMPLETE COMBUSTION, SOOTING, AND POOR FLAME QUALITY.**

Carefully position the ceramic fiber logs and twigs over the burner as shown in **Figure 7 (D, DR, DR-500), 8 (D, DT, DR-600) or 9 (D, DT, DR-800)**. For more detailed placement instructions, refer to the LOG PLACEMENT GUIDE accompanying this document.

Proper twig placement is critical to prevent sooting. Twigs should be placed in the gaps between the flame peaks and should be positioned so that at no time they impinge the flames.



(Fire shown with optional Brick Liner Kit)

Figure 7

D, DT, DR-500 MODEL



Figure 8

D, DT, DR-600 MODEL



(Fire shown with optional Brick Liner Kit)

Figure 9

D, DT, DR-800 MODEL

NOTE: DIAGRAMS & ILLUSTRATIONS NOT TO SCALE.

### Glowing Embers (Rockwool) Placement

Refer to the detailed glowing embers placement instructions provided in the **LOG PLACEMENT GUIDE** accompanying this document.

### Decorative Volcanic Stone Placement - See Figures 7, 8 and 9 on page 7.

Spread this Decorative Volcanic Stone evenly over the bottom surface of the appliance fire-box bottom plate as desired to achieve an esthetically pleasing appearance. For best results, spread in a non-uniform manner while ensuring complete coverage of the black sheet-metal surface.

**Note:** Do Not place decorative volcanic stone on top of the gas burner where it will block the burner ports.

### SIT and Honeywell Millivolt Appliance Checkout

The pilot flame should be steady, not lifting or floating. Flame should be blue in color with traces of orange at the outer edge.

The top  $\frac{3}{8}$ " (10 mm) at the pilot generator (thermopile) and the top  $\frac{1}{8}$ " min (tip) of the quick drop out thermocouple should be engulfed in the pilot flame. The flame should project 1" (25 mm) beyond the hood at all three ports (**Figure 10 - SIT, Figure 11 - Honeywell**).

To light the burner, refer to the lighting instructions on **pages 11 and 12** for Honeywell and SIT millivolt gas valves).

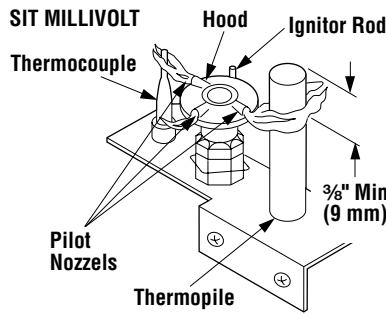

Figure 10

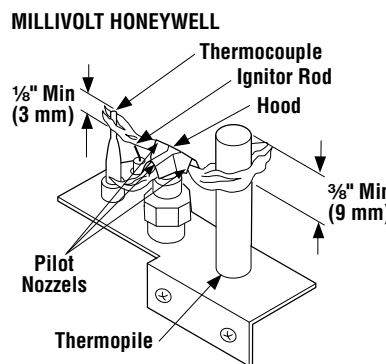

Figure 11

### Electronic Appliance Checkout

To light the burner, refer to the lighting instructions on **page 14 and 15**. Ensure the ignitor lights the pilot. The pilot flame should engulf the flame sensor as shown in **Figure 12**.

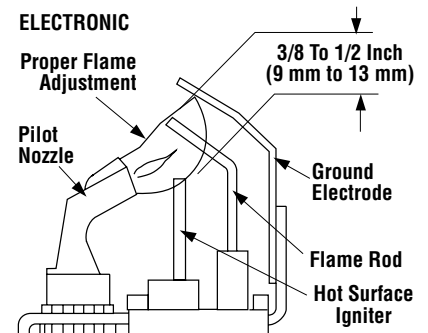

Figure 12

With proper care and maintenance, your appliance will provide many years of enjoyment. If you should experience any problem, first refer to the trouble shooting guide in this manual. If problem persists, contact your Lennox distributor.



## WIRING DIAGRAMS

Wiring diagrams are provided here for reference purposes only. This information is also provided on schematics attached directly to the appliance on a pullout panel located within the control compartment.

**CAUTION: LABEL ALL WIRES PRIOR TO DISCONNECTION WHEN SERVICING CONTROLS. WIRING ERRORS CAN CAUSE IMPROPER AND DANGEROUS APPLIANCE OPERATION.**

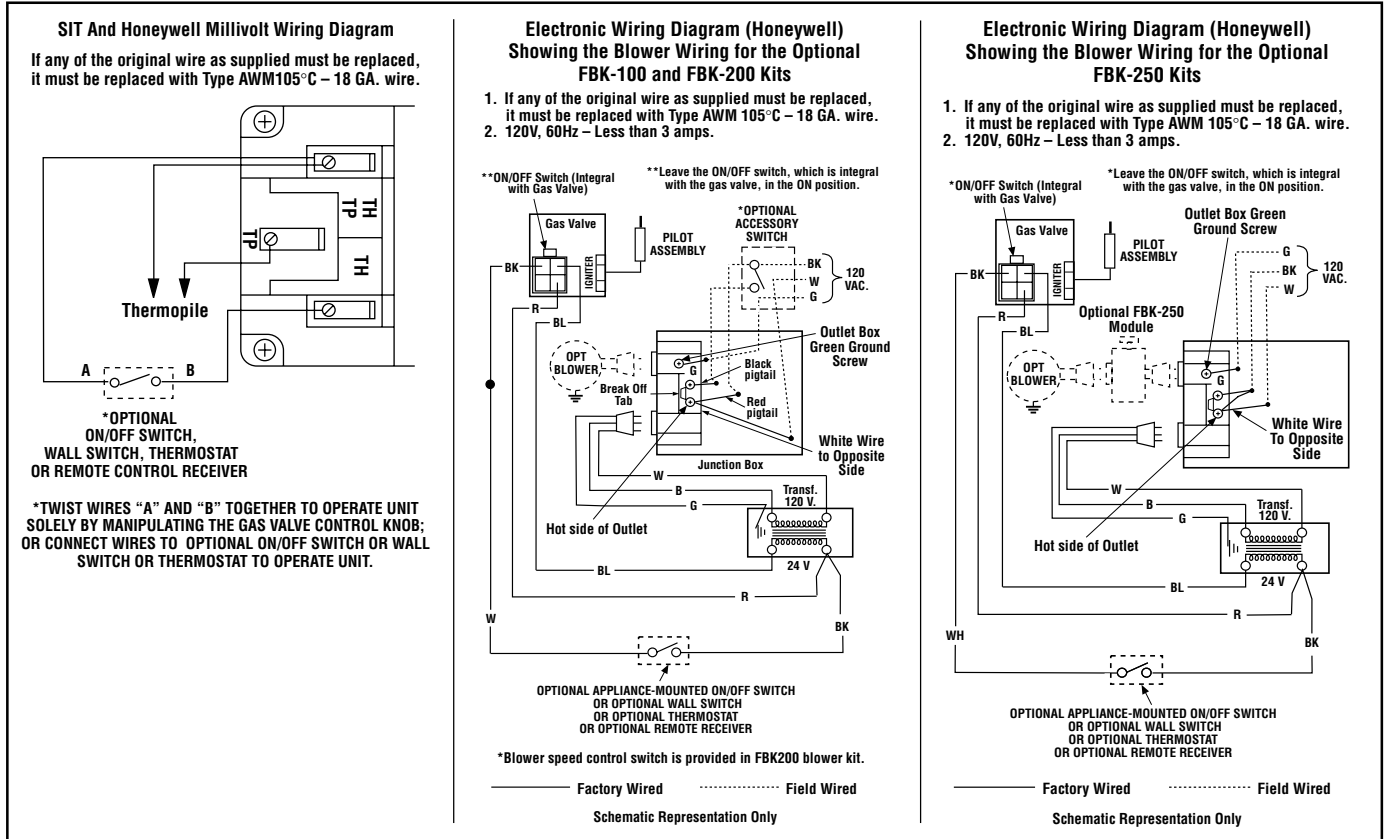

## WARRANTY

Your gas appliance is covered by a limited twenty year warranty. You will find a copy of the warranty accompanying this manual. Please read the warranty to be familiar with its coverage.

Retain this manual. File it with your other documents for future reference.

## REPLACEMENT PARTS

A complete parts list is found at the end of this manual. Use only parts supplied from the manufacturer.

Normally, all parts should be ordered through your Lennox distributor or dealer. Parts will be shipped at prevailing prices at time of order.

When ordering repair parts, always give the following information:

- The model number of the appliance.
- The serial number of the appliance.
- The part number.
- The description of the part.
- The quantity required.
- The installation date of the appliance.

If you encounter any problems or have any questions concerning the installation or application of this system, please contact your distributor, or Lennox directly:

**LHP**  
**1110 West Taft Avenue**  
**Orange, CA 92865**

## PRODUCT REFERENCE INFORMATION

We recommend that you record the following important information about your fireplace. Please contact your Lennox dealer for any questions or concerns. For the number of your nearest Lennox dealer, please call 800-731-8101

Your Fireplace's Model Number \_\_\_\_\_

Your Fireplace's Serial Number \_\_\_\_\_

The Date On Which Your Fireplace Was Installed \_\_\_\_\_

The Type of Gas Your Fireplace Uses \_\_\_\_\_

Your Dealer's Name \_\_\_\_\_

NOTE: DIAGRAMS & ILLUSTRATIONS NOT TO SCALE.

## ACCESSORY COMPONENTS



Remote Control System (Standard) H0249 RCL

### Standard Remote Control System

The Model RCL (Standard) Remote Control System, features a simple On/Off control function for the fireplace. This model includes a hand-held transmitter, a remote receiver with wall-mount coverplate and all hardware required to install the unit. The remote receiver can be wall or hearth mounted.

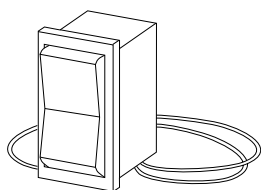

Rocker Switch Kit 80L41 FRS

### Unit-Mountable Rocker Switch

This rocker switch kit can be installed directly in the gas valve mounting bracket (millivolt gas valve equipped fireplaces) to provide On/Off operation in lieu of a wall switch.

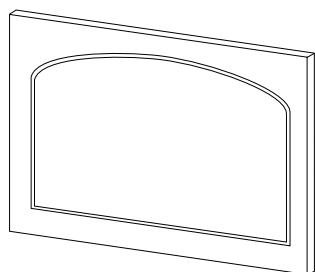

Remote Control System (Deluxe) H0251 RCL-T

### Deluxe Remote Control System

The Model RCL-T (Deluxe) Remote Control System has all of the features of the standard system along with an added easy to read LCD screen which presents access to many enhancements, including; battery power level indicator, timer, mode of operation, thermostatic display including room temperature in either metric or English units, flame indicator and clock. Fully programmable, the Model RCL-T allows for command over nearly all operational and temperature variables, using the hand held remote control transmitter.



Touch-Up Paint (Black) Kit 90L73 FTPK-B  
Touch-Up Paint (Tan) Kit 98K67

### Touch-Up Paint Kit

Repair of minor scratches and discoloration of the appliance's painted surfaces may be accomplished with the use of these touch-up paint kits.

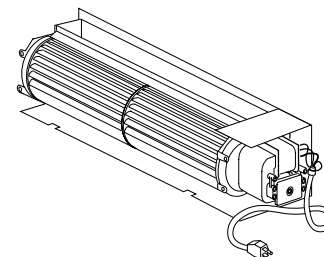

Forced Air Blower Kits  
-Single Speed 80L84 FBK-100  
-Variable Speed with wall-mountable switch 80L85 FBK-200  
-Variable Speed with unit- or wall-mountable switch 80L86 FBK-250

### Forced Air Kit

The FBK-100 blower provides constant velocity forced air circulation. The FBK-200 assembly with variable speed, wall-mountable switch provides variable speed forced air circulation. The FBK-250 assembly with variable speed wall- or unit-mountable switch, also provides variable speed forced air circulation.

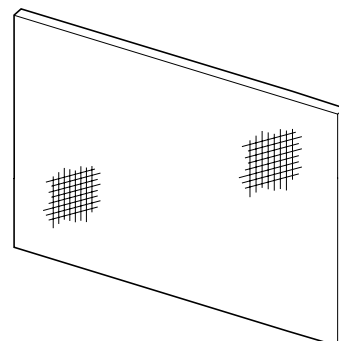

### Screen Panel Kits

Model No.	Catalog No. Model No.
D, DT, DR-500	80L43 SPK-5
D, DT, DR-600	80L44 SPK-6/60
D, DT, DR-800	80L45 SPK-8/80

These screen panels can be installed on the glass enclosure panel to provided protection from the hot glass surface. The screen panel kits cannot be used in conjunction with either of the arch door kits or door frame kits.

### Arch Door Kits

Catalog No.  
Model No.

Model No.	D, DT, DR-500	D, DT, DR-600	D, DT, DR-800
Polished Brass Finish	80L92 ADK-5B	80L93 ADK-6/60B	80L94 ADK-8/80B
Brushed Stainless Finish	81L02 ADK-5BS	81L03 ADK-6/60BS	81L04 ADK-8/80BS

NOTE: DIAGRAMS & ILLUSTRATIONS NOT TO SCALE.

## ACCESSORY COMPONENTS CONTINUED

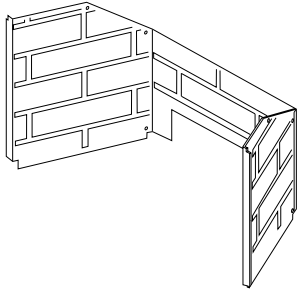

Brick Liner Kits		
Model No.	Catalog No. Model No.	
	Rear Vent	Top Vent
<b>D, DT, DR-500</b>	80L03 BLK-5R	80L01 BLK-5T
<b>D, DT, DR-600</b>	80L04 BLK-6R	80L02 BLK-6T
<b>D, DT, DR-800</b>	80L05 BLK-8R	99L22 BLK-8T

The brickade liner kits include tan stamped sheetmetal panels for the rear and side walls of the firebox. The panels have brick-like features in relief. These kits can be retrofitted into previously installed appliances.

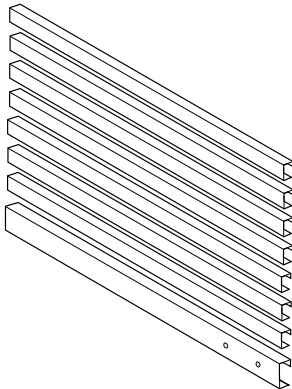

Louver Kits		
Model No.	Catalog No. Model No.	
	Polished Brass	Brushed Stainless
<b>D, DT, DR-500</b>	80L68 LK-5/50B	80L72 LK-5/50BS
<b>D, DT, DR-600</b>	80L69 LK-6/60B	80L73 LK-6/60BS
<b>D, DT, DR-800</b>	80L70 LK-8/80B	80L74 LK-8/80BS

These louvers are designed to replace the standard black louvers that come with the fireplace, or the radiant panels that are also available with the fireplace. Eight louvers are provided in the kit.

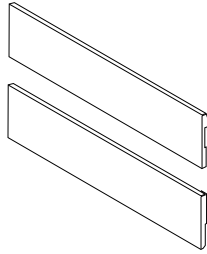

Clean Face Panel Kits		
Model No.	Catalog No. Model No.	
	Polished Brass	Brushed Stainless
<b>D, DT, DR-500</b>	80L76 CFPK-5/50	80L60 HK-5/50BS
<b>D, DT, DR-600</b>	80L77 CFPK-6/60	80L61 HK-6/60BS
<b>D, DT, DR-800</b>	80L78 CFPK-8/80	80L62 HK-8/80BS

Clean faced panel kits are available to convert the standard louvered fireplaces to radiant models which are more suited for finishing around the firebox opening with non-combustible materials, such as tile.

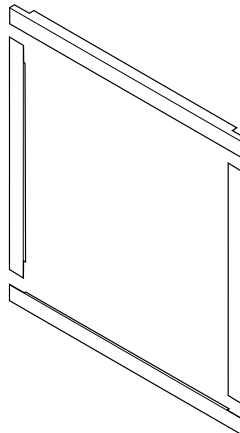

Door Frame Kits		
Model No.	Catalog No. Model No.	
	Polished Brass	Brushed Stainless
<b>D, DT, DR-500</b>	80L11 DFK-5B	80L16 DFK-5BS
<b>D, DT, DR-600</b>	80L12 DFK-6/60B	80L17 DFK-6/60BS
<b>D, DT, DR-800</b>	80L13 DFK-8/80B	80L18 DFK-8/80BS

These kits are designed to attach directly to the front face of the fireplace at the four edges of the glass enclosure panel.

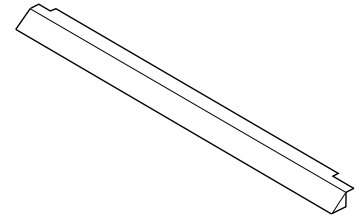

Hood Kits		
Model No.	Catalog No. Model No.	
	Polished Brass	Brushed Stainless
<b>D, DT, DR-500</b>	80L52 HK-5/50B	80L60 HK-5/50BS
<b>D, DT, DR-600</b>	80L53 HK-6/60B	80L61 HK-6/60BS
<b>D, DT, DR-800</b>	80L54 HK-8/80B	80L62 HK-8/80BS

These hood kits replace the standard hood that comes with these fireplaces.

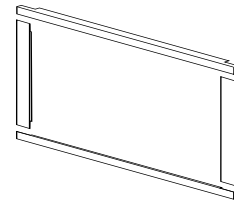

2-Piece Door Frame Kits		
Model No.	Catalog No. Kit Model No.	
	Polished Brass	Brushed Stainless
<b>B-500</b>	19M85 DTK-5B	19M86 DTK-5BS
<b>B-600</b>	19M89 DTK-6/60B	19M90 DTK-6/60BS
<b>B-800</b>	19M93 DTK-8/80B	19M94 DTK-8/80BS

These kits are designed to attach directly to the front face of the fireplace at the top and bottom edges of the glass enclosure panel.

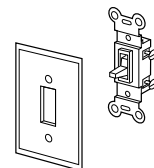

**ON/OFF Wall Switch Kit**      **85L87**      **FWSK**

The ON/OFF wall switch kit may be used to control the operation of the fireplace burner as an alternative to the modesty panel mounted ON-OFF switch. Install the ON/OFF wall switch in a convenient location near the fireplace.

NOTE: DIAGRAMS & ILLUSTRATIONS NOT TO SCALE.

## LIGHTING INSTRUCTIONS – HONEYWELL AND SIT MILLIVOLT GAS VALVE

### FOR YOUR SAFETY READ BEFORE LIGHTING

**WARNING: IF YOU DO NOT FOLLOW THESE INSTRUCTIONS EXACTLY, A FIRE OR EXPLOSION MAY RESULT CAUSING PROPERTY DAMAGE, PERSONAL INJURY OR LOSS OF LIFE.**

- A.** This appliance has a pilot which must be lighted with a piezo ignitor. When lighting the pilot, follow these instructions exactly.
- B. BEFORE OPERATING** smell all around the appliance area for gas. Be sure to smell next to the floor because some gas is heavier than air and will settle on the floor.
- WHAT TO DO IF YOU SMELL GAS**
- Extinguish any open flame.
  - Open windows.
  - Do not light any appliance.
  - Do not touch any electrical switches.
  - Do not use any phone in your building.
  - Immediately call your gas supplier from a neighbor's phone.
  - If your gas supplier cannot be reached, call the fire department.
- C.** Use only your hand to push in or turn the gas control knob. Never use tools. If the knob will not push in or turn by hand, do not try to repair it, call a qualified service technician. Force or attempted repair may result in a fire or an explosion.
- D.** Do not use this appliance if any part has been under water. Immediately call a qualified service technician to inspect the appliance and to replace any part of the control system and any gas control which has been under water.

### LIGHTING INSTRUCTIONS

- STOP!** Read the safety information above on this page.
- Access the lower control compartment.
- Turn remote wall switch to "OFF."
- Verify main line shut-off valve is open.
- Push in gas control knob slightly and turn clockwise to "OFF."
- Wait five (5) minutes to clear out any gas. If you then smell gas, STOP! Follow "B" in the safety information above on this page. If you do not smell gas, go to the next step.
- Push in gas control knob slightly and turn counterclockwise to "PILOT."
- Push in control knob all the way and hold in. Immediately light the pilot by triggering the spark ignitor (pushing the button) until pilot lights. Continue to hold the control knob in for about 1 ½ minutes after the pilot is lit. Release knob and it will pop back up. Pilot should remain lit. If it goes out, repeat steps 5 through 8.
- Turn gas control knob counterclockwise to "ON."
- Close lower control compartment.

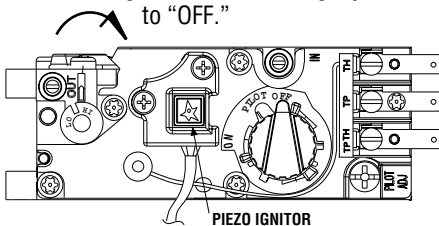

**HONEYWELL  
MILLIVOLT  
GAS VALVE**

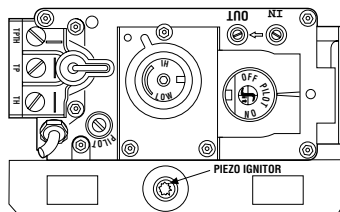

**SIT  
MILLIVOLT  
GAS VALVE**

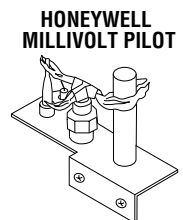

**HONEYWELL  
MILLIVOLT PILOT**

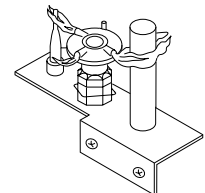

**SIT  
MILLIVOLT PILOT**

**Note:** Knob cannot be turned from "PILOT" to "OFF" unless the knob is pushed in slightly. Do not force.

### TO TURN OFF GAS TO APPLIANCE

- Turn remote wall switch "OFF." The pilot will remain lit for normal service.
- For complete shutdown, turn remote wall switch to "OFF."
- Access the lower control compartment.
- Depress gas control knob slightly and turn clockwise to "OFF." Do not force.
- Close lower control compartment.



## INSTRUCTIONS D'ALLUMAGE – VANNE GAZ MILLIVOLT HONEYWELL ET SIT

### POUR VOTRE SÉCURITÉ, LISEZ CES INSTRUCTIONS AVANT L'ALLUMAGE

**AVERTISSEMENT : SI VOUS NE SUIVEZ PAS CES INSTRUCTIONS À LA LETTRE, IL POURRAIT S'EN SUIVRE UN INCENDIE OU UNE EXPLOSION CAUSANT DES DOMMAGES MATÉRIELS, DES BLESSURES CORPORELLES OU MÊME DES PERTES DE VIE.**

- A. Cet appareil est muni d'une veilleuse qui doit être allumée avec un allumeur piézo-électrique. Lorsque vous allumez la veilleuse, suivez exactement ces instructions.
- B. **AVANT L'ALLUMAGE:** Assurez-vous que vous ne détectez aucune odeur de gaz autour de l'appareil ainsi que près du sol; certains gaz, étant plus lourds que l'air, descendent au niveau du sol.  
**VOICI CE QUE VOUS DEVEZ FAIRE SI VOUS DÉCELEZ UNE ODEUR DE GAZ:**
- Éteignez toute flamme visible.
  - Ouvrez les fenêtres.
  - N'allumez aucun appareil.
  - Ne touchez à aucun commutateur électrique.
  - Ne vous servez d'aucun téléphone dans votre édifice.
- C. Appelez immédiatement votre compagnie de gaz en utilisant le téléphone du voisin.
- S'il vous est impossible de contacter votre compagnie de gaz, appelez le service des incendies.
- C. N'utilisez que votre main pour manipuler le bouton de réglage du gaz. N'utilisez jamais d'outils. Si le bouton refuse de tourner ou de bouger, n'essayez pas de le réparer. Communiquez immédiatement avec un technicien de service qualifié. Toute tentative pour le forcer ou le réparer, risquerait de provoquer un incendie ou une explosion.
- D. Ne vous servez pas de cet appareil si l'un de ses éléments a été immergé dans l'eau. Appelez immédiatement un technicien compétent pour faire inspecter l'appareil et remplacer toute pièce du système de réglage ou commande du gaz qui a été sous l'eau.

### INSTRUCTIONS D'ALLUMAGE

1. **ARRÊTEZ!** Lisez les consignes de sécurité au verso de cette plaque.
2. Ouvrez le compartiment de contrôle du bas.
3. Tournez l'interrupteur mural à la position d'arrêt "OFF".
4. Assurez-vous que la soupape d'arrêt de la canalisation principale est ouverte.
5. Enfoncez légèrement le bouton de réglage du gaz et tournez-le dans le sens des aiguilles d'une montre  jusqu'à la position d'arrêt "OFF".

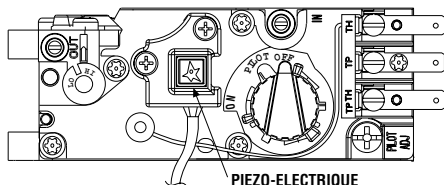

VANNE GAZ  
MILLIVOLT  
HONEYWELL

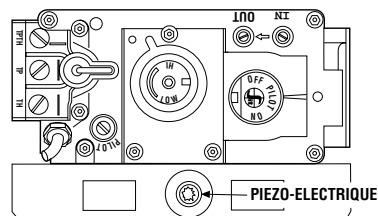

VANNE GAZ  
MILLIVOLT  
SIT

**Remarque:** Il est impossible de tourner le bouton de "PILOT" à "OFF" à moins qu'il ne soit légèrement enfoncé. Ne le forcez pas.

6. Attendez cinq (5) minutes pour l'évacuation du gaz. Si vous décelez une odeur de gaz, ARRÊTEZ ! Retournez au point "B" des consignes de sécurité au verso de cette plaque. Si vous ne remarquez aucune odeur de gaz, passez à l'étape suivante.
7. Enfoncez légèrement le bouton de réglage du gaz et tournez-le en sens inverse des aiguilles d'une montre jusqu'à la position de veilleuse  "PILOT".

8. Enfoncez le bouton de réglage jusqu'au fond et gardez-le enfoncé. Allumez immédiatement la veilleuse en déclenchant l'allume-gaz à étincelle (en poussant le bouton) jusqu'à ce que la veilleuse s'enflamme. Continuez de tenir le bouton de réglage enfoncé pendant environ 90 secondes après l'allumage de la veilleuse. Relâchez le bouton et il sortira subitement. La veilleuse devrait rester allumée. Si elle s'éteint, répétez les étapes 5 à 8 inclusivement.

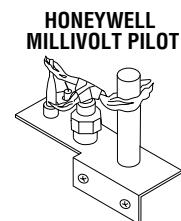

- Si le bouton ne sort pas automatiquement après avoir été relâché, arrêtez immédiatement et téléphonez à votre technicien de service ou à votre fournisseur de gaz.

- Si la veilleuse refuse de rester allumée après plusieurs tentatives, tournez le bouton de réglage jusqu'à sa position d'arrêt "OFF" et téléphonez à votre technicien de service ou à votre fournisseur de gaz.

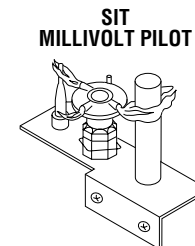

9. Tournez le bouton de réglage du gaz en sens inverse des aiguilles d'une montre  jusqu'à sa position de marche "ON".
10. Fermez le compartiment de contrôle du bas.
11. Au besoin, rebrancher l'appareil au courant électrique et remettre l'interrupteur du brûleur principal à la position "ON" ou régler le thermostat à la température désirée.
12. Si l'appareil ne fonctionne pas, suivre les instructions intitulées "Pour fermer le gaz qui alimente l'appareil" et appeler un technicien ou le fournisseur de gaz.

### POUR FERMER LE GAZ QUI ALIMENTE L'APPAREIL

1. Tournez l'interrupteur mural à la position d'arrêt "OFF". La veilleuse restera allumée jusqu'au retour du service normal.
2. Pour une fermeture complète, tournez l'interrupteur mural à la position d'arrêt "OFF".
3. Ouvrez le compartiment de contrôle du bas.
4. Enfoncez légèrement le bouton de réglage du gaz et tournez-le dans le sens des aiguilles d'une montre  jusqu'à la position d'arrêt "OFF". Ne forcez pas le bouton.
5. Fermez le compartiment de contrôle du bas.

## LIGHTING INSTRUCTIONS — ELECTRONIC

### FOR YOUR SAFETY READ BEFORE LIGHTING

**WARNING: IF YOU DO NOT FOLLOW THESE INSTRUCTIONS EXACTLY, A FIRE OR EXPLOSION MAY RESULT CAUSING PROPERTY DAMAGE, PERSONAL INJURY OR LOSS OF LIFE.**

- A.** When lighting the appliance, follow these instructions exactly.
- B. BEFORE OPERATING** smell all around the appliance area for gas. Be sure to smell next to the floor because some gas is heavier than air and will settle on the floor.
- WHAT TO DO IF YOU SMELL GAS**
- Extinguish any open flame.
  - Open windows.
  - Do not light any appliance.
  - Do not touch any electrical switches.
  - Do not use any phone in your building.
- Immediately call your gas supplier from a neighbor's phone.
  - If your gas supplier cannot be reached, call the fire department.
- C.** Use only your hand to turn the gas control lever. Never use tools. If the lever will not turn by hand, do not try to repair it, call a qualified service technician. Force or attempted repair may result in a fire or an explosion.
- D.** Do not use this appliance if any part has been under water. Immediately call a qualified service technician to inspect the appliance and to replace any part of the control system and any gas control which has been under water.

### LIGHTING INSTRUCTIONS

1. **STOP!** Read the safety information above on this page.
2. Turn remote wall switch to "OFF."
3. Open lower control compartment door.
4. Verify main line shut-off valve is open.
5. Turn the ON/OFF switch to "OFF". Do not force.
6. Wait five (5) minutes to clear out any gas. If you then smell gas, STOP! Follow "B" in the safety information above on this page. If you do not smell gas, go to the next step.
7. Turn the ON/OFF switch to "ON". Do not force.
8. Turn "ON" all electrical power to appliance (remote wall switch).
9. Close lower control compartment door.

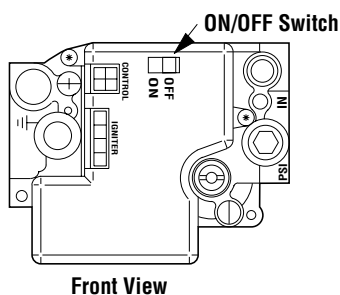

### TO SHUT OFF

1. Turn off all electrical power to the appliance (remote wall switch).

### TO TURN OFF GAS TO APPLIANCE

1. For complete shut-down, turn remote wall switch to "OFF."
2. Open lower control compartment door.
3. Turn the ON/OFF switch to "OFF". Do not force.
4. Close the main line shut-off valve.
5. Close lower control compartment door.

## INSTRUCTIONS D'ALLUMAGE — ELECTRONIC

### POUR VOTRE SÉCURITÉ, LISEZ CES INSTRUCTIONS AVANT L'ALLUMAGE

**AVERTISSEMENT: SI VOUS NE SUIVEZ PAS CES INSTRUCTIONS À LA LETTRE, IL POURRAIT S'EN SUIVRE UN INCENDIE OU UNE EXPLOSION CAUSANT DES DOMMAGES MATÉRIELS, DES BLESSURES CORPORELLES OU MÊME DES PERTES DE VIE.**

- A.** Lorsque vous allumez l'appareil, suivez exactement ces instructions.
- B. AVANT L'ALLUMAGE:** Assurez-vous que vous ne détectez aucune odeur de gaz autour de l'appareil ainsi que près du sol; certains gaz, étant plus lourds que l'air, descendent au niveau du sol.
- VOICI CE QUE VOUS DEVEZ FAIRE SI VOUS DÉCELEZ UNE ODEUR DE GAZ**
- Éteignez toute flamme visible.
  - Ouvrez les fenêtres.
  - N'allumez aucun appareil.
  - Ne touchez à aucun commutateur électrique.
  - Ne vous servez d'aucun téléphone dans votre édifice.
- C.** N'utilisez que votre main pour manipuler l'interrupteur "ON/OFF" de la valve à gaz. N'utilisez jamais d'outils. Si l'interrupteur ne bouge pas manuellement, n'essayez pas de le réparer. Communiquez immédiatement avec un technicien de service qualifié. Toute tentative pour forcer l'interrupteur ou le réparer, risquerait de provoquer un incendie ou une explosion.
- D.** Ne vous servez pas de cet appareil si l'un de ses éléments a été immergé dans l'eau. Appelez immédiatement un technicien compétent pour faire inspecter l'appareil et remplacer toute pièce du système de réglage ou commande du gaz qui a été sous l'eau.
- E.** Appelez immédiatement votre compagnie de gaz en utilisant le téléphone du voisin.
- F.** S'il vous est impossible de contacter votre compagnie de gaz, appelez le service des incendies.

### INSTRUCTIONS D'ALLUMAGE

- 1. ARRÊTEZ !** Lisez les consignes de sécurité au verso de cette plaque.
2. Tournez l'interrupteur mural à la position d'arrêt "OFF".
3. Ouvrez la porte du compartiment de contrôle du bas.
4. Assurez-vous que la soupape d'arrêt de la canalisation principale est ouverte.
5. Tournez la manette de réglage du gaz à la position d'arrêt "OFF".
6. Attendez cinq (5) minutes pour l'évacuation du gaz. Si vous décelez une odeur de gaz ARRÊTEZ ! Retournez au point "B" des consignes de sécurité au verso de cette plaque. Si vous ne remarquez aucune odeur de gaz, passez à l'étape suivante.
7. Tournez la manette de réglage du gaz jusqu'à la position de marche "ON". Ne la forcez pas.
8. Ouvrez le courant électrique ("ON") qui alimente l'appareil (interrupteur mural).
9. Fermez la porte du compartiment de contrôle du bas.
10. Au besoin, rebrancher l'appareil au courant électrique et remettre l'interrupteur principal du brûleur à la position "ON" ou régler le thermostat à la température désirée.
11. Si l'appareil ne se met pas en marche, suivre les instructions intitulées "Pour fermer le gaz qui alimente l'appareil" et appeler un technicien ou le fournisseur de gaz.

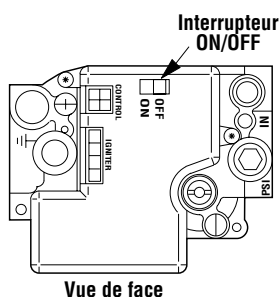

Vue de face

### POUR ÉTEINDRE L'APPAREIL

1. Coupez tout le courant électrique qui alimente l'appareil (interrupteur mural).

### POUR FERMER LE GAZ QUI ALIMENTE L'APPAREIL

1. Pour une fermeture complète, tournez l'interrupteur mural à la position d'arrêt "OFF".
2. Ouvrez la porte du compartiment de contrôle du bas.
3. Tournez la manette de réglage du gaz à la position d'arrêt "OFF". Ne la forcez pas.
4. Fermez la soupape d'arrêt de la canalisation principale.
5. Fermez la porte du compartiment de contrôle du bas.

# TROUBLESHOOTING THE MILLIVOLT GAS CONTROL SYSTEM

**Note:** Before troubleshooting the gas control system, be sure external gas shut off valve (located at gas supply inlet) is in the "ON" position.

**Important:** Valve system troubleshooting should only be accomplished by a qualified service technician.

SYMPTOM	POSSIBLE CAUSES	CORRECTIVE ACTION
1. Spark ignitor will not light pilot after repeated triggering of ignitor button.	A. Defective ignitor (no spark at electrode).	Check for spark at electrode and pilot; if no spark and electrode wire is properly connected, replace ignitor.
	B. Defective or misaligned electrode at pilot (spark at electrode).	Using a match, light pilot. If pilot lights, turn off pilot and trigger the ignitor button again. If pilot lights, an improper gas mixture caused the bad lighting and a longer purge period is recommended. If pilot will not light – check gap at electrode and pilot – should be 1/8" to have a strong spark. If gap measures 1/8", replace pilot ( <b>Figure 10 on page 8- SIT, Figure 11 on page 8- Honeywell</b> ).
	C. Gas supply pressure errant.	Check inlet gas pressure. It should be within the limits as marked on the rating plate.
	D. Pilot orifice plugged.	Clean or replace pilot orifice.
2. Pilot will not stay lit after carefully following the lighting instructions.	A. Defective pilot generator (thermocouple).	Check pilot flame, it must impinge on thermocouple ( <b>Figure 10 on page 8- SIT, Figure 11 on page 8- Honeywell</b> ). Clean and/or adjust pilot for maximum flame impingement on thermocouple. Ensure that the connection between the valve and thermocouple are tight and secure.
3. Pilot burning, no gas to burner, Valve knob "ON," Wall Switch "ON."	A. Wall switch or wires defective.	Check wall switch and wires for proper connections. Jumper wire across terminals at wall switch, if burner comes on, replace defective wall switch. If okay, jumper wires across wall switch wires at valve, if burner comes on, wires are faulty or connections are bad.
	B. Thermopile may not be generating sufficient millivoltage.	Check thermopile with millivolt meter. Take reading at thermopile terminals of gas valve. Should read 325 millivolts minimum with optional wall switch "OFF." Replace faulty thermopile if reading is below specified minimum.
	C. Plugged burner orifice.	Check burner orifice for stoppage and remove.
4. Frequent pilot/burner outage problem.	A. Pilot flame may be too low or blowing (high) causing the pilot/valve safety to drop out.	Clean and/or adjust pilot flame for maximum flame impingement on thermocouple ( <b>Figure 10 on page 8- SIT, Figure 11 on page 8- Honeywell</b> ).





## REPLACEMENT PARTS LIST

No.	DESCRIPTION	D, DT, DR-500		D, DT, DR-600		D, DT, DR-800	
		Part No.	Qty.	Part No.	Qty.	Part No.	Qty.
	Gas Fireplace Assembly	—	—	—	—	—	—
1.	Hood	LB-91941BZ	1	LB-91941CZ	1	LB-91941DZ	1
2.	Louver	LB-92400BZ	7	LB-92400CZ	7	LB-92400DZ	7
3.	Louver, (Base)	LB-92402BZ	1	LB-92402CZ	1	LB-92402DZ	1
4.	Enclosure, Glass Front (Complete)	LB-92534B	1	LB-92534C	1	LB-92534D	1
5.	Nameplate (Brand)	56L9301	1	56L9301	1	56L9301	1
6.	Latch	69L2101	2	69L2101	2	69L2101	2
7.	Catch, Door, Magnetic	69L3101	1	69L3101	1	69L3101	1
8.	Log Set (Complete)	69L6901	1	69L7701	1	74L3001	1
9.	Burner Assembly	69L0901	1	69L1001	1	69L1101	1
10.	Burner Bracket	LB-92357	3	LB-92357	3	LB-92357	3
11.	Ember Screen	LB-92438B	1	LB-92438C	1	LB-92438D	1
12.	Log Grate Assembly	LB-92406B	1	LB-92406C	1	LB-92406D	1
13.	Orifice, Main Burner - <b>Nat. Gas</b>	37L7001	1	18L4001	1	99K7701	1
13.	Orifice, Main Burner - <b>LP Gas</b>	99K9701	1	LB-55874D	1	74L8801	1
14.	Bag of Embers (Rockwool)	88L53	1	88L53	1	88L53	1
15.	Bag of Decorative Volcanic Stone	80L42	1	80L42	1	80L42	1
16.	Gas Line Flexible Connector	93L32	1	93L32	1	93L32	1
17.	Magnet	094326	1	094326	1	094326	1

### GAS CONTROLS — SIT MILLIVOLT

No.	DESCRIPTION	Natural		Propane	
		Part No.	Qty.	Part No.	Qty.
20.	Gas Valve - SIT	43K0701	1	88J5301	1
21.	Piezo Igniter	10K8601	1	10K8601	1
22.	Pilot Assembly	69L1701	1	69L1801	1
23.	Pilot Generator	60J7901	1	60J7901	1
24.	Thermocouple	74L5701	1	74L5701	1
25.	Pilot Tube	74L5601	1	74L5601	1
26.	Electrode And Cable	74L5801	1	74L5801	1
27.	Pilot Shield	LB-92706	1	LB-92706	1

### GAS CONTROLS — HONEYWELL MILLIVOLT

No.	DESCRIPTION	Natural		Propane	
		Part No.	Qty.	Part No.	Qty.
30.	Gas Valve	82L8601	1	82L8701	1
31.	Pilot Assembly	67L7001	1	67L7001	1
32.	Pilot Generator	60J7901	1	60J7901	1
33.	Thermocouple	67L6701	1	67L6701	1
34.	Pilot Tube	67L6801	1	67L6801	1
35.	Electrode And Cable	67L8701	1	67L8701	1
36.	Piezo Igniter	24M8901	1	24M8901	1
37.	Pilot Shield	LB-92706	1	LB-92706	1

### GAS CONTROLS — ELECTRONIC

No.	DESCRIPTION	Natural		Propane	
		Part No.	Qty.	Part No.	Qty.
40.	Gas Valve - Honeywell	62L1801	1	62L1901	1
41.	Pilot Assembly	62L1401	1	62L1501	1
42.	Transformer	42J3201	1	42J3201	1
43.	Ignitor Assembly (Kit)	87L54	1	87L54	1

# REPLACEMENT PARTS

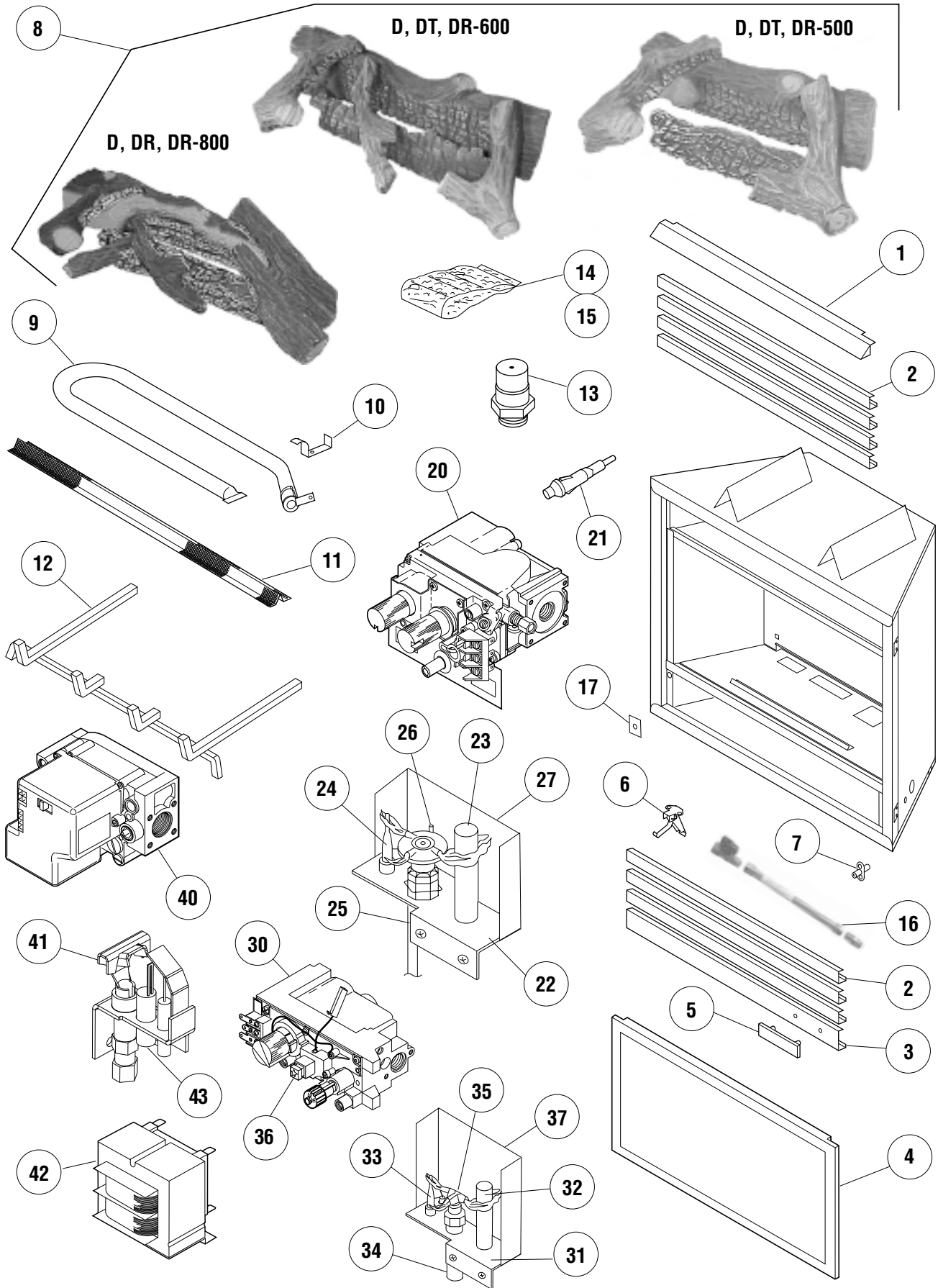

NOTE: DIAGRAMS & ILLUSTRATIONS NOT TO SCALE.

---

The manufacturer reserves the right to make changes at any time, without notice, in design, materials, specifications, prices and also to discontinue colors, styles and products.  
Consult your local distributor for fireplace code information.

Printed in U.S.A. © 2002 by Lennox Hearth Products  
**P/N 725,032M REV. H 11/2004**

**LHP**  
**1110 West Taft Avenue • Orange, CA 92865**