

CAZO FIRE PIT - NARROW LEDGE

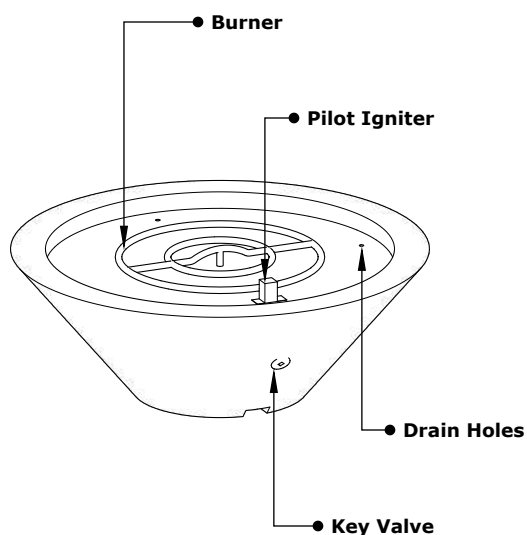

ISOMETRIC VIEW

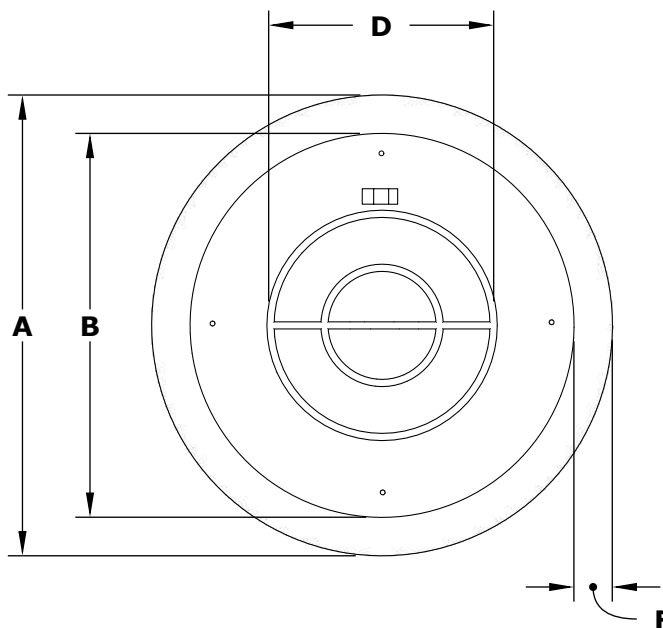

TOP VIEW

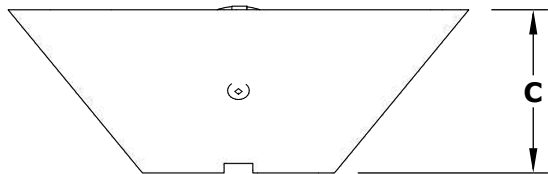

FRONT SIDE VIEW

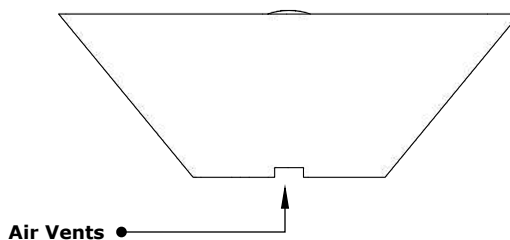

BACK SIDE VIEW

PART NUMBER	A	B	C	D	E	F	BTU
OPT-CZNL48	48"	40"	17"	18"	20"	4"	65,000
OPT-CZNL48EKIT	48"	40"	17"	18"	20"	4"	65,000
OPT-CZNL60	60"	50"	21"	24"	28"	5"	65,000
OPT-CZNL60EKIT	60"	50"	21"	24"	28"	5"	65,000

Fire Pit Material: GFRC Concrete
 Pan Material: 304 Stainless Steel
 Burner Material: 304 Stainless Steel
 Ignition Type: Match Lit or Electronic
 Standard 2" Depth on all pans
110V ELECTRONIC IGNITION
 ANSI Z21.97-(2017) / CSA 2.41-(2017)



Match Lit Unit Includes: Pan, Burner, Gas Orifice, Gas Hoses, Key Valve, Key,
 110v Ignition Unit Includes: Pan, Burner, Gas Orifice, Gas Hoses, Key Valve, Key, Plug & Play Electronic Valve, Pilot Igniter.